

**INSTALLATION**

**MANUAL**

***SX-V SPECIAL  
SECURITY SYSTEM***



**SX-V SPECIAL**  
**SECURITY SYSTEM**  
REFERENCE and  
**INSTALLATION Manual**

§ 5/20/93§

---

## Table of Contents

INTRODUCTION .....	4
CPU FEATURES SUMMARY .....	5
GENERAL PRINCIPLES .....	11
INTERIOR AND EXTERIOR SOUNDS .....	12
INTERIOR SOUNDS ONLY .....	12
PROTECTION LEVELS .....	13
SENSOR NUMBERING .....	14
GROUP NUMBERS .....	14
UPPER SENSOR NUMBERS .....	16
OPTIONAL FEATURE NUMBERS .....	19
SENSOR GROUP CHART .....	20
THE CPU .....	21
CPU INSTALLATION .....	24
CPU CONNECTIONS .....	25
TAMPERING THE RJ-31X JACK .....	27
CPU HARDWIRE TAMPER INPUT .....	29
TOUCHPADS .....	30
SENSORS .....	37
DOOR/WINDOW SENSOR .....	38
SMOKE SENSOR 60-352 .....	42
PASSIVE INFRARED MOTION SENSOR .....	45
SIRENS .....	48
HARDWIRE INTERIOR SIREN AND PIEZO .....	50
HARDWIRE INTERIOR SIREN .....	51
HARDWIRE EXTERIOR SIREN .....	52
WIRELESS INTERIOR SIREN .....	53
PROGRAMMING .....	56
PROGRAMMING THE CPU .....	57
SENSOR PROGRAMMING .....	60
PROGRAMMING CPU OPTIONS .....	62
UPPER SENSOR NUMBERS .....	65
OPTIONAL FEATURE NUMBERS .....	69
CONNECTING THE CPU TO THE CENTRAL STATION .....	74
BUDDY SYSTEM BACK-UP REPORTING CAPABILITIES .....	79
TESTING .....	80
TESTING YOUR WORK .....	81
MAINTENANCE AND INSPECTIONS .....	89
TELEPHONE PROBLEMS .....	90
APPENDIX A Hardwire Output Module (HOM) .....	1A
APPENDIX B Key Switch .....	1B
APPENDIX C Alarm LED .....	1C
APPENDIX D Wireless Shatterbox 5745-03 .....	1D
APPENDIX E Shock Sensor Sentrol 5105 .....	1E
APPENDIX F SD11-17 Siren Driver .....	1F
APPENDIX G Hardwire Input Module (HIM) .....	1G

## INTRODUCTION

This Installation Manual is designed to give you the information necessary to install and test the security system.

It is assumed that the technicians reading this manual have thoroughly familiarized themselves with the operation of the system. You cannot be expected to understand how to install the System unless you already know how to use it.

If you are not yet familiar with how to use the system then do the following before proceeding:

- (1) Get a *DEMONSTRATION KIT* with which to practice.
- (2) Get a copy of the customer's *OWNER'S MANUAL* and be sure you understand everything contained in it.
- (3) Set up the *DEMO KIT* and all its components and practice all its functions including:
  - a. How to arm and disarm to every level of protection
  - b. Know the difference between each arming level
  - c. Understand the status sounds
  - d. Practice the *BYPASS* feature
  - e. Try arming with a sensor violated to see & hear what happens
  - f. Set a *TEMPORARY ACCESS CODE*
  - g. Become familiar with the alarm sounds, *BURGLARY, FIRE & MEDICAL*
  - h. Activate the silent *DURESS CODE*
  - i. Be sure you understand all display information on the CPU
  - j. Try a *SENSOR TEST* (level 9)
  - k. Practice changing the *PROGRAMMING* of the CPU
  - l. Check the *ALARM MEMORY* feature

### PRE-INSTALLATION SET UP RECOMMENDATION

With this system you have a unique opportunity to "install" much of the system even before you leave your office.

All systems must be pre-programmed and tested at the office prior to the installation day. Companies that do this have seen a 10% - 20% reduction in the TOTAL time spent. On-site time can be cut by as much as 50%!

Set up a test bench in your office with all the proper tools and equipment including; a non-switched, grounded 110 volt outlet, and an RJ-31X jack. Power up and program the CPU, Touchpads and sensors as if you were at the job site.

## CPU FEATURES SUMMARY

- ACCESS CODES:** 34 Access Codes Total: 2 Primary Access Codes (can select all protection levels), 8 Secondary Access Codes (can select all levels or can be restricted to certain levels), 22 Secondary Access Codes (restricted to certain levels only), 1 Temporary Access Code, and 1 Duress Code. Temporary Access Code, Duress Code and 1 Primary Access Code are field programmable. All codes are Central Station (CS) programmable. Multiple codes identify openings/closing by user.
- ACCOUNT NUMBER:** 5 digits, can be alpha-numeric; CS programmable.
- AC FAILURE:** Optional feature, Sensor 111, CPU reports AC failure to CS if no AC for 15 minutes, CPU display shuts off after 15 minutes of failed AC.
- ALARM MEMORY:** Alarms which occurred during previous arming period can be reviewed locally; press STATUS, watch CPU display. Memory clears by selecting level 9 or automatically after 6 hours.
- ALARM REPORTING** Sensors report individually to CS. Multiple sensor alarms report in the order they were tripped. Cancel report sent if protection level changed.
- APPROVALS:** Equipment manufactured by Interactive Technologies, Inc. has been tested and is in compliance with FCC Rules, Part 15, Subpart J and E and Part 68 where applicable. Each device carries a label giving the specifics and conditions of compliance.
- BATTERY LIFE:** Lithium batteries, 5-8 years; 9 volt Alkaline batteries 12-18 months.
- BATTERY TYPE:** CPU - 3.2 amp hour, 6 volt DC Lead Acid. two maximum per CPU. Touchpads, PIR and Door/Window sensors use 3.6 volt DC lithium. Smoke sensors use (2) 9 volt alkaline, Wireless Interior Sirens (WIS) use 9 volt alkaline or rechargeable 9 volt NiCad.
- BATTERY MONITORING:** Lithium batteries, and 9 volt batteries monitored, tested every 69 minutes; CPU battery - monitored, tested weekly.
- BATTERY SAVER ROUTINE (CPU):** CPU displays turn off 15 minutes after AC loss. CPU shuts itself off after 2-3 days to save battery & CPU memory. Battery holds CPU memory for days. Powers up in same level as when shut down.
- BUDDY SYSTEM: (PHONE TAMPER)** Optional feature, Sensor 100, which allows a nearby CPU to report alarms for a CPU whose phone connection is unusable. Each CPU can "buddy" with up to 4 other CPU's.
- BYPASS SENSORS:** Sensors can be bypassed directly or indirectly using a Touchpad. They are bypassed automatically if the system is "armed" with sensors left open. (Force Armed Auto).

*Introduction Cont.*

<b>BYPASS TOGGLE:</b>	Optional feature, F17, allows bypassed sensors to be unbypassed by repeating the commands used to direct bypass.
<b>CALL BACK AUTOMATIC:</b>	Central Station command that instructs CPU to call back one time after a designated time. (10-2560 minutes, in 10 minute increments)
<b>CARRIER CURRENT SIGNALING:</b>	Used by CPU to signal WIS (through CPU power transformer terminal 3) over AC power lines, FSK format. The X-10 Light Control is also signaled.
<b>CLOCK, REAL TIME:</b>	CPU real time clock used to assign times for event buffer. Set by Central Station.
<b>COMMUNICATOR:</b>	Built-in to CPU, Bell 103 format, uses RJ-31X, reports special ITI format. By zone: Alarm, Alarm Canceled, Supervisory, Trouble Sensor Bypassed, Restorals, Trouble conditions. Pulse dials up to 14 digits, CS programmable.
<b>COMMUNICATOR MODES:</b>	Programmed from CS only.  PMODE 0 = Dial 1 phone number only - default PMODE.  PMODE 1 = Dial second phone number only after 3 unsuccessful tries to first phone number.  PMODE 2 = Dial first phone number for all alarms and cancels only. Dial second phone number for trouble and supervisory only.  PMODE 3 = Dial first phone number for all alarms and cancels only. Dial second phone number for everything.  PMODE 4 = Dial first phone number for all alarms except opening/closing. Dial second phone number for everything.
<b>COMPATIBILITY:</b>	CPU equipment is compatible only with other ITI LEARN MODE equipment.
<b>CONTENTION:</b>	Several sensors can transmit to the CPU simultaneously and still be received due to a sophisticated reporting format.
<b>CRYSTAL CONTROL:</b>	All transmitters and the CPU receiver are crystal controlled to achieve a very narrow bandwidth (25 KHz). This results in a supersensitive receiver.
<b>DELAY TIMES:</b>	Entry/Exit delay times programmable independently from 04 to 60 seconds from Touchpad or CS. Preset to 32 seconds.
<b>DIALER ABORT:</b>	Optional feature, F06, which aborts call to CS if user cancels alarm before dialing to CS is complete. Does not function for FIRE or DURESS calls.

*Introduction Cont.*

DISPLAY (CPU):	CPU display shows: current protection level, sensor status, CPU power status. Used to review alarm memory. Viewed during programming to check data. Power LED: flashes, when CPU on battery power; steady when CPU on AC; out, when no power to CPU.
DISPLAY DURING FAILURE:	Display shuts off after 15 minutes on standby battery except power LED which flashes. Pressing STATUS momentarily reveals display. Display lights for 5 minutes on alarm.
DURESS CODE:	Programmable by CS or Touchpad. Code used to silently signal the CS of Duress situation. First two digits are the same as primary Access Code. Duress Code can be entered at any level to activate.
EVENT BUFFER:	64 event history buffer stores date, time, user ID for each event. Stores alarms, trouble, supervisories, bypassing, arming and disarming, and if used open and closing reports. Viewed from CS.
EXTERIOR SIREN:	Exterior siren sounds for police and fire alarms only.
EXTERIOR SIREN DELAY:	Optional feature, F02, which causes a 15 second delay before activating exterior sirens hardwired to the CPU. Exterior sirens hardwired to the WIS can be delayed by setting a dip switch.
EXTERIOR SIREN TIME OUT:	See Siren Time Out.
FAIL TO COMMUNICATE:	Activates if CPU cannot report information to CS. Sounds trouble beeps every 60 seconds locally if CPU is unsuccessful after three attempts. Five attempts are made before giving up.
FAST FORWARD/ PROGRAM:	Button on CPU which speeds up CPU display in program mode for easier program review.
FORCE ARM:	User can force arm the system with a sensor unrestored using the BYPASS button. Optionally the force arming can be reported to CS.
FORCE ARM AUTO:	CPU will automatically force arm to the level user attempted to select if user attempted to arm with sensors unrestored. Force arming occurs after three minutes. Unrestored sensors will be bypassed. Force Armed Auto is reported to CS.
FREQUENCY:	Crystal controlled for all RF transmitters and matched to CPU Receiver, factory set, not field tunable.
HARDWIRE INPUT/ OUTPUT:	CPU has Hardwire I/O terminals for: Pinpoint Multiplex Module, Hardwire Input Module, Hardwire Touchpad Display, Hardwire Interior Siren, Hardwire Exterior Siren, N/O or N/C tamper circuit.

*Introduction Cont.*

<b>HARDWIRE BUS:</b>	A hardwire reporting format or protocol which allows for up to 8 hardwired units to be interfaced to the CPU. Each device is assigned a unit number and is supervised similarly to an RF sensor.
<b>MICROPROCESSOR:</b>	The CPU is microprocessor based.
<b>OPENING/CLOSING REPORTS:</b>	Available as optional sensor numbers 107 and 108, identifies particular user by ID number.
<b>OPTIONAL FEATURE NUMBERS:</b>	16 optional features can be programmed to customize the installation.
<b>OPTIONAL SENSOR NUMBERS:</b>	9 Optional sensor numbers used to describe various trouble, test and convenience options.
<b>PHONE TAMPER:</b>	If the CPU cannot report an alarm signal due to phone line tamper it can optionally activate a transmitter which could be heard by a nearby CPU. The nearby CPU can report the phone tamper condition and identify the CPU which couldn't communicate (see Buddy System).
<b>PHONE LINE TESTING</b>	The CPU can optionally be programmed to test the phone line hourly, F14, and/or before communicating, Sensor 118. It can also be programmed to call the CS at a programmable interval (from daily to 256 days) This feature, Sensor 114, defaults to every 7 days.
<b>PHONE NUMBER CAPABILITY:</b>	Two numbers up to 14 digits long. CS can program pauses between digits. Pauses count as digits. See Communicator Modes.
<b>PINPOINT:</b>	Future use
<b>PROTECTION LEVELS:</b>	8 Arming levels, 2 test levels. Secondary Access Codes can be restricted from certain levels.
<b>RAM TEST:</b>	The CPU completely tests its RAM memory on power-up. This takes 2 1/2 - 4 minutes. If there is a problem it displays "bad".
<b>RECEIVER:</b>	The CPU contains a crystal controlled superhetrodyne receiver with dual antenna spatial diversity.
<b>RECEIVER FAILURE:</b>	If the CPU hears no signals for 2 hours, it reports 115 RECEIVER FAILURE to the CS.
<b>SENSORS:</b>	Devices designed to detect a variety of conditions such as open/close status, fire, smoke, motion etc. and activate a transmitter which will report to the CPU.



*Introduction Cont.*

- SENSOR NUMBERS:** 99 installer definable Sensor Numbers (zones) report individually to the CS. 11 pre-programmed sensor numbers describe trouble, test or emergency conditions. 9 Optional sensor numbers describe additional trouble, test and convenience conditions.
- SENSOR TAMPER:** Switch, integral to the DWS, which causes a tamper signal to transmit when the cover is removed. CPU responds accordingly.
- SENSOR TEST:** Protection level 9, allows testing of all sensors with the CPU. CPU will visually and audibly acknowledge successful test.
- SIREN DELAY:** Feature, F02, which allows 15 second delay before activating exterior sirens directly hardwired to the CPU.
- SIREN TIMEOUT:** CS programmable from 1 to 15 minutes, preset to 5 minutes.
- SIREN SOUNDS:** Burglary, Fire, Medical, Status, Protest, Trouble, Entry pre-alarm, Exit delay. Chime, Sensor Test indications.
- SIREN SOUNDS (HIS):** An Optional CPU feature, F11, controls whether Hardwire Interior Sirens will sound alarms only, or alarm and status sounds.
- SIREN SOUNDS (WIS):** A switch in the WIS controls whether the WIS will produce alarm sounds only or alarm and status sounds.
- SUPERVISED:** Supervised Sensors report to the CPU every 69 minutes. The CPU looks every 12 hours for sensor reports. If no reports have been received from a sensor the CPU reports the condition immediately to the CS. Trouble beeps will sound locally after 10 hours if the problem is not corrected.
- SUPERVISORY PROTESTS:** If a sensor has a Trouble (usually a low battery) or Supervisory condition, the CPU will protest (as if a sensor has been left open) when an attempt is made to arm the system to a protection level in which the sensor is active. You can, however, arm to level 0 without getting the protests. The CPU display will show the problem sensor number and light the appropriate condition LED. If all the LED's are flashing, it means the sensor is open or the tamper switch has been activated. The customer must acknowledge the Supervisory or Trouble condition by arming using the Bypass key. This will not bypass the sensor unless it is open.
- SUPERVISORY PROGRAMMING:** The CPU can be programmed for what time of day to re-report unrepaired supervisories (STIME).
- TAMPER (TOUCHPAD):** Sensor number is programmed which will report to CS if the CPU hears 40 Touchpad keystrokes that do not equal the access code + a protection level.
- TAMPER (CPU):** The CPU door is tampered. The switch is wired N.C. but can be reconfigured for N.O. Other devices could be wired into the same circuit.
- TRANSMITTERS:** Connect to switches or sensors and send RF signals to the CPU.

*Introduction Cont.*

**TROUBLE:**

The CPU activates Trouble Beeps (6 quick beeps, once each minute) 10 hours after it has detected a Supervisory or 7 days after a Low Battery condition. The Trouble Beeps will also sound when the system has been left in the program mode. The beeps will stop by leaving the program mode, however the Trouble Beeps caused by Supervisories or Low Batteries will re-activate every 10 hours if they have not been corrected. Changing the arming level resets the 10 hour timer.

**UNIT NUMBER:**

A unique number to designate the devices connected to the hardwire buss. Supervisories will be reported to CS by unit number.

## **GENERAL PRINCIPLES**

### **Receiver**

The CPU contains an extremely sensitive, crystal controlled superhetrodyne receiver which is capable of receiving signals from over 500 feet away, open field. The band width is approximately 100 times narrower than previous models which reduces the chance of interference from other sources. In addition, the dual antenna spatial diversity receiver virtually eliminates phase nulls and dead spots.

### **Frequency**

The Central Processing Unit (main security control panel) and all associated devices (transmitters, motion sensors, touchpads & sirens) used in an installation must all have the same frequency to communicate to each other. The frequency is set at the factory and is marked on all components

All Devices for a particular job (CPU, sensors, sirens, etc), must have the same factory set frequency.

### **Full Time Sensors**

Activation of the sensors listed below will cause an alarm 24 hours a day.

- All emergency push buttons on the touchpad
- Fire and Smoke sensors
- Environmental Sensors ( Freeze, Furnace failure, etc.)
- 24-hour police emergency sensors (usually portable panic buttons)
- 24-hour auxiliary emergency sensors (usually portable panic buttons)

### **SIREN sounds**

The CPU initiates a variety of alarm and system status sounds. Sounds can be produced by the Wireless Interior Siren, Hardwire Interior Siren, Hardwire Touchpad display and Hardwire Exterior Siren. Not all sounds are produced by all siren types. Sections of this manual which describe the various sirens, identify the sounds they can make. Both alarm siren sounds and status "beeps" can be made to sound throughout the installation site.

## **INTERIOR AND EXTERIOR SOUNDS**

**POLICE SIREN** - loud intermittent tone.

**FIRE SIREN** - loud steady tone.

## **INTERIOR SOUNDS ONLY**

**AUXILIARY SOUNDS** - Low volume, on-off on-off beeping.

**STATUS SOUNDS** - Low volume beeps which indicate the CPU's current protection level.

**PROTEST BEEP** - Low volume rhythmic two-tone beeping sound when an arming attempt is made which indicates a Trouble or Supervisory condition or that a sensor is open.

**TROUBLE OR SUPERVISORY BEEPS** - Six quick low volume beeps repeated every sixty (60) seconds. Occurs as an automatic indicator if a trouble or supervisory condition exists and no change occurred in arming level for 10 hours.

**CHIME BEEP** - A pair of low volume tone which indicates a perimeter sensor has been opened and the CPU is armed to protection level 2.

**SENSOR TEST SOUND** - Loud single tone or series of tones heard when testing sensors in protection level 9.

**EXIT DELAY SOUNDS** - Low volume status sounds which indicate the beginning of the Exit Delay Time when levels 3 and 5 are selected. The status beeps sound repeatedly for the duration of the Exit Delay Time.

**ENTRY DELAY SOUNDS** - Low volume repeated status sounds which indicate that the Entry Delay Time is in progress.

## PROTECTION LEVELS

The CPU has several arming levels. Each needs to be understood.

- Level 0**      **DISARM/CANCEL** - (One long beep)  
All intrusion sensors off, full time sensors (fire, medical, panic and environmental ) ON.
- Level 1**      **SPECIAL** - (One short beep)  
Same as Level "0" but special intrusion sensors (silver drawer, gun cabinet, wall safe, etc.) are active and will remain active through level 7.
- Level 2**      **CHIME** - (Two short beeps)  
Special Intrusion Sensors plus chime feature (all exterior sensors will cause chime tone when activated).
- Level 3**      **HOME AWAKE** - (Three short beeps)  
Special Intrusion Sensors plus Perimeter Sensors armed with delays. All interior sensors disarmed. Typically used during daytime or early evenings while at home.
- Level 4**      **HOME ASLEEP** - (Four short beeps)  
Same as level three, but entry and exit delay times are instant. Used during night hours after all expected residents have arrived (some interior sensors active).
- Level 5**      **AWAY DELAY** - (Five short beeps)  
Special Intrusion Sensors plus ALL OTHER intrusion sensors, both interior and exterior, armed with delays.
- Level 6**      **AWAY INSTANT** - (One long & one short beep)  
Special Intrusion Sensor plus ALL OTHER intrusion sensors, both interior and exterior, armed with NO delays.
- Level 7**      **SILENT AWAY** - (One long & two short beeps)  
Same as level 6 but intrusion alarms are silent. (Can only be turned on from the Central Station.
- Level 8**      **PHONE TEST** - (One long & three short beeps)  
This will send a communications test signal over the phone lines to the Central Station. Test is acknowledged at residence by activation of each siren sound for 2 seconds.  
*Note:* Level 8 changes to level 0 after successfully communicating to the receiver. If it fails to reach the receiver after three (3) tries the CPU will display 117 (fail to communicate), but continues to try and call for a total of 8 attempts.
- Level 9**      **SENSOR TEST** - (One long & four short beeps)  
This level is used to test each sensor (transmitter). The CPU will acknowledge a successful test by first displaying the sensor number reporting in and then removing it from the sensor number display window scroll on the front of the CPU. The sirens connected to the CPU emit a loud "beep" upon activation.

## SENSOR NUMBERING

The CPU has 99 zones which can be programmed for any purpose. Zone or Sensor Numbers assigned to sensors must also be programmed into the CPU memory.

**NOTE:** In this manual we will often use the term SENSOR. Sensors are simply RF transmitters. We will also use the term SENSOR NUMBER, this is simply the zone number of that SENSOR.

The Central Processing Unit (CPU) recognizes these different Sensor Numbers as having different functions. For example, some are used for fire, some for intrusion, some for medical, etc.

Before installing a SENSOR, first pick an appropriate Group Number from 00 to 10. Refer to the following chart. For example, a smoke sensor or rate-of-rise detector would need to be programmed with a Group Number of 10. A medical emergency sensor should have a Group Number of 01. A delayed entry door should have a Group Number of 03.

### GROUP NUMBERS

The following groups can be received, displayed at the CPU and reported to the Central Station. The Sensor Numbers of all transmitters used in an installation must be programmed into the CPU memory in order to function.

<u>GROUP NUMBER</u>	<u>DESCRIPTION</u>
0	<b>Police / Emergency</b> Reports in all levels except level 9 <i>High Level Modulated Siren</i>
1	<b>Auxiliary / Medical</b> Reports in all levels except level 9 <i>Low Level Siren</i>
2	<b>Special</b> Reports in levels 1-7 <i>High Level Modulated Siren</i> Silent in Level 7
3	<b>Main Entry</b> Reports in levels 3-7 Chime if in level 2 Initiates delay in level 3 and 5 <i>High Level Modulated Siren</i> Silent in Level 7
4	<b>Perimeter</b> Reports in levels 3-7 Chime if in level 2 <i>High Level Modulated Siren</i> Silent in Level 7

<b>GROUP NUMBER</b>	<b>DESCRIPTION</b>
5	<b>Interior Delayed</b> Reports in levels 4-7 Disarmed by delay in level 5 <i>High Level Modulated Siren</i> Silent in Level 7
6	<b>Interior Delayed</b> Reports in levels 5-7 Disarmed by delay in level 5 <i>High Level Modulated Siren</i> Silent in Level 7
7	<b>Interior (starts delay)</b> Reports in levels 4 - 7 Initiates delay in level 5 <i>High Level Modulated Siren</i> Silent in Level 7
8	<b>Interior (starts delay)</b> Reports in levels 5 - 7 Initiates delay in level 5 <i>High Level Modulated Siren</i> Silent in Level 7
9	<b>Silent Panic</b> Reports in all levels except level 9 <i>No Sirens</i>
F (10)	<b>Fire</b> Reports in all levels except level 9 <i>High Level Continuous Siren</i>

Groups 5 and 6 will be delayed only if a sensor which initiates the entry delay time (Group 3, 7, 8) is activated first to start the delay. If an intruder entered an unprotected window and then tripped a sensor in group 5 or 6, the alarm would sound instantly.

### **SENSOR CONTENTION**

The CPU virtually eliminates any contention if two or more sensors transmit at the exact same moment. Each transmitter sends multiple rounds of information when in alarm with different timing intervals so as the signals cannot block each other. In addition, emergency signals for fire and panic are given priority over burglary signals, and all emergencies have priority over supervisory and restoral signals.

## UPPER SENSOR NUMBERS

The following is a description of pre-programmed sensor numbers resident in the CPU's memory. Those numbers that are marked with a PRE are pre-programmed. Those numbers that are marked with OPT are optional sensors that can be turned on at the time of installation if desired. You can delete or re-initialize a pre-programmed sensor according to your customer's specific installation requirements.

CPU DISPLAY	SENSOR NUMBER	SENSOR TYPE	DESCRIPTION
A0	100	OPT	<b>PHONE TAMPER</b> If the CPU cannot report a violation to the Central Station for Sensor Numbers 01-99, 103, 104, 105, 109 and 113 because of phone line problems, it has a hardwire output that can activate a transmitter. Another CPU within range of the transmitter can be programmed to report the account number and phone tamper condition of the CPU which originally experienced the alarm condition.
A1	101	OPT	<b>TOUCHPAD TAMPER.</b> If the CPU hears 40 Touchpad signals that do not equal the proper access code, plus a protection level. The Sirens will go into audible alarm, (police siren) and report "101 TOUCHPAD TAMPER" to the Central Station.
A2	102	OPT	<b>Hardwire Supervisory.</b> If a hardwire buss device quits reporting in, a 102 Supervisory will be reported along with the unit number of the buss device.
A3	103	PRE	<b>24 -HOUR FIRE CALL</b> from a Touchpad. Audible.
A4	104	PRE	<b>24 -HOUR POLICE CALL</b> from a Touchpad. Audible.
A5	105	PRE	<b>24 -HOUR AUXILIARY CALL</b> from a Touchpad. Audible.
A6	106	PRE	<b>PHONE TEST</b> initiated by customer. After a successful test, all sirens sound briefly at the customers home or the Central Station operator should call. In addition, the 106 will clear from the CPU display and the CPU will return to Level 0.
A7	107	OPT	<b>OPENING REPORT.</b> If 107 is initialized, the CPU will report "107 OPENING REPORT" when the CPU is disarmed. There are provisions for identifying up to 34 different users of the system.
A8	108	OPT	<b>CLOSING REPORT.</b> If 108 is initialized, the CPU will report "108 CLOSING REPORT" when the CPU is armed. There are provisions for identifying up to 34 different users of the system.



CPU DISPLAY	SENSOR NUMBER	SENSOR TYPE	DESCRIPTION
A9	109	PRE	<b>DURESS CODE.</b> A specially programmed access code that will send a 24-hour POLICE EMERGENCY CALL silently to the Central Station. The Duress Code must be followed by any protection level number to activate. <u>This sensor number will not display on the CPU, it will just report.</u> Even though sensor number 109 is pre-programmed, it will not report unless the installer has entered a duress code into the CPU memory.
C0	110	OPT	<b>FORCE ARMED.</b> If 110 is initialized, the CPU will report "110 FORCE ARMED" whenever a sensor number is deliberately bypassed by a user. The CPU will report "110 FORCE ARMED AUTO" if it force armed itself.
C1	111	OPT	<b>A/C FAILURE.</b> If 111 is initialized, the CPU will report "111 A/C FAILURE" when the AC power at the outlet that the CPU is plugged into has been off for 15 minutes. The CPU will report 112 A/C POWER RESTORED when the power comes back on.
C2	112	PRE	<b>LOW CPU BATTERY</b> After this report is sent to the Central Station (typically 2 to 3 days after AC failure) the CPU is about to shut down until the AC POWER is restored. This shut down prevents deep battery discharge and loss of CPU memory. The memory will be OK for several weeks without AC, however the battery may need to be replaced. When the AC power is restored, the CPU will re-arm itself to the same protection level that it was in when it powered down. Up to two back up batteries can be installed in the CPU. Using two batteries will approximately double the standby time. The CPU could report 112 as a POWER SUPPLY FAILURE. This condition is usually due to a blown DC Input Fuse, a back-up battery that won't take a charge, or if the power supply chip has failed.
C3	113	OPT	<b>CPU TAMPER</b> The CPU can connect a N/C or N/O hardwire tamper input to the door. This hardwire tamper input can also have other devices such as the exterior siren tamper or RJ-31X phone cord tamper connected to it. The tamper input can be configured either N/O or N/C. The central station report will be 113 alarm tamper loop.
C4	114	OPT	<b>AUTOMATIC PHONE TEST.</b> If 114 is initialized, the CPU will report "114 AUTOMATIC PHONE TEST" to the Central Station at a programmable interval. From daily to every 255 days. If not changed from the Central Station the report will be every 7 days.
C5	115	PRE	<b>RECEIVER FAILURE</b> The CPU will report "115 RECEIVER FAILURE" if it <u>does not hear from any</u> transmitter for 2 hours.

CPU DISPLAY	SENSOR NUMBER	SENSOR TYPE	DESCRIPTION
C6	116	OPT	<b>CPU BACK IN SERVICE</b> After the CPU has gone into its battery saver shut down routine, which is designed to prevent deep battery discharge and CPU memory loss, the 116 signal is sent when the AC power has been restored. The CPU is BACK IN SERVICE. The CPU will come back on armed to the same protection level it was in when it shut down.
C7	117	PRE	<b>FAIL TO COMMUNICATE</b> The CPU makes 3 attempts to contact the Central Station. If the CPU can't get through (after 3 attempts), a 117 will be displayed at the CPU and a trouble tone will sound every 60 seconds. The tone can be silenced by entering the ACCESS CODE + 0. This alarm gives a local indication only. The control unit will continue to make a total of 8 attempts to reach the central station in any of the PMODES programmed.
C8	118	PRE	<b>NO PHONE LINE.</b> If 118 is initialized, the CPU will check the phone line before attempting any communication with the Central Station. If the phone line is not operational, a 118 alarm is initialized and will be displayed at the CPU. A Trouble tone will sound. The tone can be silenced by entering the ACCESS CODE + 0. This is a local indication only.
C9	119	PRE	<b>PROGRAM CHANGE / TOUCHPAD</b> (low BAT or SUPER). This signal is sent if a change is made to the panel while in program mode such as initializing a sensor, deleting a sensor, change the access code etc. A Supervisory or Low Battery on C9 (119) is a supervisory or low battery on a wireless touchpad. The touchpads number is sent to the CS-4000.

**NOTE:** For the purposes of this document, when sensor numbers are referred to, they will be in the Central Station Format (3 digits). Remember, the CPU display will show the 2-digit representation of the sensor number.

**EXAMPLE:** Central station receives 113  
 Customers Touchpad shows C3

## OPTIONAL FEATURE NUMBERS

The following OPTIONAL FEATURES can also be programmed into the CPU memory. They can also be added from the model CS-4000 Central Station Receiver as the other sensors can. All optional features power up "OFF" (except for F00 which is on at power-up) and must be programmed into the CPU to be "ON". These features are discussed in more detail in the section PROGRAMMING THE CPU.

### FEATURE | DESCRIPTION

F00	<b>EXIT DELAY SOUNDS.</b> Controls whether or not exit delay beeps will sound once at the beginning of the exit delay, or continuously for the entire length of the delay.
F01	<b>TAMPER POLARITY.</b> Controls the polarity of the Hardwire Tamper Input to the CPU.
F02	<b>EXTERIOR SIREN DELAY.</b> Controls whether or not the exterior siren output will be activated immediately or delayed 15 seconds.
F03	<b>DIGITAL COMMUNICATOR.</b> Controls whether or not the system will report alarms to a Central Station.
F04	<b>LOW BATTERY REPORTS.</b> Controls whether LOW BATTERIES are to re-report weekly or daily.
F05	<b>SUPERVISORY REPORTS.</b> Controls whether SUPERVISORIES which have not been corrected will re-report to the Central Station daily or weekly.
F06	<b>DIALER ABORT.</b> Controls whether or not the dialer should abort alarm calls that are canceled by the customer within the first 15-20 seconds.
F07	<b>ALARM LED.</b> Controls whether terminal 14 is an alarm LED output or a Hardwire Buss output.
F10	<b>SIGNAL STRENGTH INDICATOR.</b> Controls whether or not the CPU will perform a regular level 9 sensor test or will annunciate each time it hears a transmission from a tested sensor.
F11	<b>INTERIOR SIREN SOUNDS.</b> Controls whether Hardwire Interior Sirens will make status and alarm sounds or alarm sounds only.
F12	<b>RESTORE REPORTING.</b> Controls whether or not the CPU will report restorals by zone.
F13	<b>KEY SWITCH.</b> Controls whether terminal 9 is a key switch input or a buddy output.
F14	<b>HOURLY PHONE TEST.</b> Controls whether or not the CPU will check every hour to see if the phone line it is connected to is good.
F15	<b>SENSOR TAMPER.</b> Controls whether or not the CPU will treat all sensor tamper signals as alarms in all protection levels.
F16	<b>TROUBLE BEEPS.</b>
F17	<b>DIRECT BYPASS TOGGLE.</b> Controls whether or not bypassed sensors can be unbypassed directly.

## SENSOR GROUP CHART

GROUP NUMBER	SENSOR TYPE	ACTIVE LEVELS	SIREN SOUND
00	Police / Emergency	0 - 8	Loud Intermittent
01	Auxiliary / Medical	0 - 8	Low Level Siren
02	Special	1 - 7	Loud Intermittent
03	Main Entry	Reports in Chimes in 3 - 7	Loud Intermittent
04	Perimeter	Reports in Chimes in 2	Low Level Beeping
05	Interior Delayed	3 - 7	Loud Intermittent
06	Interior Delayed	2	Low Level Beeping
07	Interior (starts delay)	4 - 7	Loud Intermittent
08	Interior (starts delay)	5 - 7	Loud Intermittent
09	Silent Panic	4 - 7	Loud Intermittent
F (10)	Fire	5 - 7	Loud Intermittent
		0 - 8	Silent
		0 - 8	Loud Steady Tone

NOTE: Burglary sensors are silent in level 7.

### UPPER SENSOR NUMBERS<sup>1</sup>

SENSOR NUMBER	PURPOSE	DESCRIPTION
100	Buddy System	Refer to CPU Installation Manual.
101	TouchPad Tamper	Alarm for Multiple disarm or arm attempts.
102	Buss Device Report	Refer to CPU Installation Manual.
103	24 Hour Fire Call	TouchPad Audible
104	24 Hour Police Call	TouchPad Audible
105	24 Hour Auxiliary Call	TouchPad Audible
106	Phone Test	Customer initiated Phone Test.
107	Opening Report	If the CPU is disarmed, an opening report is sent to the central station.
108	Closing Report	If the CPU is armed, an closing report is sent to the central station.
109	Duress Code	Special Code that sends a Police Emergency Call To CS (silent).
110	Forced Armed	If CPU is armed with a sensor bypassed, a forced armed report is sent.
111	A/C Failure	If the CPU loses AC for over 15 minutes a report is sent to the C.S.
112	Low CPU Battery	Back-up Battery level is low at the CPU.
113	CPU Tamper	Enter 113 if CPU tamper loop is to be used. See Optional Feature F01 below.
114	Automatic Test	Refer to CPU Installation Manual.
115	Receiver Failure	CPU will report 115 RECEIVER FAILURE if no transmitter signal for 2 hrs.
116	CPU Back in Service	Return to service signal when AC restores.
117	Fail to Communicate	After 3 communication attempts, 117 is displayed on CPU and tone is heard.
118	No Phone Line	Telephone Line Check before attempting any communication. Local tone heard.
119	Program Change	Signal sent if a change is made to the panel in program mode.

### OPTIONAL FEATURES<sup>2</sup>

FEATURE NUMBER	PURPOSE	DESCRIPTION
F00	Exit delay sounds	Set to have exit delay beeps sound throughout delay time, instead of once.
F01	Tamper Polarity.	CPU tamper loop is N.C. Set to change it to N.O. See also sensor 113 above.
F02	Exterior Siren Delay	Set if you want the exterior siren sounds to delay for 15 seconds.
F03	Local Alarm	Set if this is a local alarm and is <i>not</i> to report to the central station.
F04	Low Battery Report	Low batteries normally report weekly. Set if they are not to report at all.
F05	Supervisory Report	Supervisories normally report daily. Set if they are to report weekly.
F06	Dialer Abort	CPU normally reports Violations and Cancels. Set for Violation reports only.
F07	Alarm LED	Set if you want to use a alarm LED or hardwire bus.
F10	Dealer Sensor Test	Set and next Sensor Test will sound one beep for each sensor round received.
F11	Interior Siren Sounds	Set if hardwire interior sirens should sound alarms only, not status beeps.
F12	Restoral Reporting	Set if you want violations to send a Restoral report when the sensor is closed.
F13	Key Switch	Set if you want to use a Key Switch on your CPU.
F14	Hourly Phone Test	Sounds trouble beeps & displays C4 if phone line is dead at time of hourly test.
F15	Sensor Tamper	Normally left off. See CPU Installation Manual.
F16	Trouble Beeps	Set if Trouble Beeps sound only for Fire Sensors.
F17	Direct Bypass Toggle	Set if you wish customer to be able to directly unbybpass bypassed sensors.

Note 1 To add an optional upper sensor, See the Programming Section.

Note 2 To add an Optional Feature see OPTIONAL FEATURES.

## THE CPU

The Central Processing Unit (CPU) is the "brain" of the security system. Its functions are to monitor and respond to signals from sensors, Touchpads, and other input devices. The CPU keeps track of sensor and system status and identifies any problems. The CPU provides audible and visual indications of the system's status. Appropriate siren sounds are also controlled by the CPU. When necessary, the CPU can communicate detailed reports to the Central Station. The CPU coordinates all system functions.

### SPECIFICATIONS

#### **MICROPROCESSOR BASED CIRCUIT BOARD**

The CPU is microprocessor based to ensure maximum reliability and versatility. The Microprocessor analyzes data it receives and then acts on the data according to its pre-programmed instructions. System functions are coordinated and directed by the microprocessor.

#### **THE RECEIVER**

The CPU uses a quartz crystal accurate Double Conversion superheterodyne receiver with a 25 KHz bandwidth. The Dual Antenna Spatial Diversity receiver minimizes phase nulls and dead spots, assuring signal reception.

#### **DIMENSIONS**

2 7/8" d x 9" w x 11.5" h (+9" antennas)  
14 gauge steel chassis  
18 gauge steel door w/lock.

#### **FCC SPECIFICATIONS**

FCC ID NUMBER:  
B4Z8NW-11892-AL-R  
RINGER EQUIVALENCE NUMBER:  
0.1B

#### **TEMPERATURE RANGE**

32° F to 95° F

#### **AC/DC POWER INDICATOR**

The red power LED indicates the following:

*STEADY GLOW* - AC power is ON

*FLASHING ON AND OFF* - The AC power is OFF and the backup battery is supplying power.

*NOT LIT* - The CPU has entered into its memory preservation shut down mode or the power switch has been turned off.

**NOTE:** When the system is powered by the standby battery, the CPU will shut down all visual status indications after about 15 minutes to conserve power. Pressing the STATUS button on a Touchpad will momentarily light the CPU display (1 second - 2 minutes, depending on the clock cycle) showing current conditions. An alarm condition will light the display for 5 minutes.

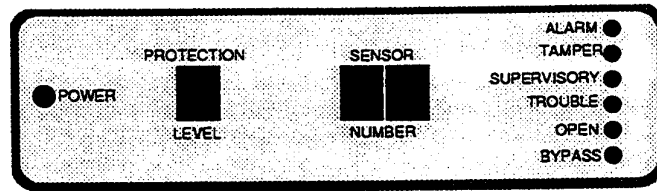

### PROTECTION LEVEL DISPLAY

The Protection Level Display window shows the protection level to which the system is armed, from 0 to 9. The window displays "P" any time the CPU is in the Program Mode. The CPU will enter the Program Review Mode when you turn the Program Mode Switch "ON". Additionally, when setting a Temporary Access Code or when Direct Bypassing sensor numbers, the CPU automatically switches to the Program Mode for a few seconds and then reverts back to the previous protection level after the change takes place.

### SENSOR NUMBER DISPLAY

The Sensor Number display shows (in this order on display windows) which sensors (1) are in ALARM, (2) have a SUPERVISORY condition, (3) have a TROUBLE condition, (4) are BYPASSED, (5) are in TAMPER, or (6) are OPEN. If a sensor has a trouble condition, is bypassed, is in alarm or has a supervisory condition, the sensor number will appear on the display and the appropriate condition LED will light.

The sensor number display also indicates any sensors which are not restored when the customer attempts to arm the system. For example, if a customer attempts to arm his system to LEVEL 3 (home awake) with a door #34 and a window #40 open, the interior sirens would make repeated protest beeps and the numbers 34 and 40 would flash in the sensor number window along with all 6 LEDs. After seeing which sensors are open, the customer can then go to door number 34 and window 40 and close them. This causes the numbers to clear from the display and the beeping to stop. The customer can now arm the system.

If a sensor has a trouble (usually low battery) or supervisory condition, the problem sensor number and appropriate condition LED will light. Attempting to arm the system will cause "Protest" beeps to sound. To determine whether the protest beeps are due to an open sensor or a problem sensor, watch the condition LEDs. All six flashing indicates a sensor is open, a particular one flashing will identify the cause of the protest. Sensors protesting with a trouble or Supervisory condition can be temporarily silenced by pressing the BYPASS button.

The sensor number display will show the number of open sensors when the CPU is in protection level 0, 1 or 2. Open sensors can be distinguished from sensors experiencing an alarm, supervisory, trouble or bypass condition because open sensors display their number and the "OPEN" LED will be lit.

*CPU Cont.*

### **SUPERVISORY INDICATIONS**

Every 69 minutes each sensor sends a supervisory signal to the CPU. If no signals have been heard from a particular sensor after approximately 12 hours, the number of the problem sensor is displayed and the "SUPERVISORY" LED is lit. The problem sensor will be reported to the Central Station. It will be re-reported once a day at STIME (or optionally once a week) until the CPU hears from the sensor. The CPU will protest to indicate the supervisory condition as the arming level is changed (except Level 0). Trouble beeps will sound every 60 seconds as an indicator of an existing supervisory condition if no change in arming level has occurred for 10 hours.

The interval at which the CPU checks to see if sensors have reported is every 12 hours. The reports to the Central Station can be daily or weekly at STIME, see Programming Section.

Each time the CPU checks for supervisories, it looks for and reports all supervisory conditions. The supervisory condition will be removed automatically if the CPU receives a transmission from the missing sensor or if the system is armed to protection level 9.

### **ALARM MEMORY**

The sensor number display can be viewed to determine if there are any alarms in memory. If STATUS is pressed, the system will give an audible indication of its current protection level and the displays will show the sensor number of any sensors which were in alarm during the previous arming period. Sensors which were in alarm are retained in the alarm memory for six hours after the system is disarmed. The alarm memory will be cleared immediately by arming to Level 9.

### **LINE CARRIER POWER TRANSFORMER**

The power transformer supplies a DC voltage of approximately 13 to 14 VDC (unloaded) to the CPU through terminals 1 and 2. Additionally, it contains the line carrier circuitry for the Wireless Interior Siren through terminal 3. The AC power indicator voltage for the CPU is carried through terminal 4.

### **RECHARGEABLE STANDBY BATTERY**

The CPU uses 6 volt 3.2 amp hour rechargeable lead acid batteries for standby power. The battery compartment behind the CPU board has room for two batteries. At the maximum normal standby current draw of 200 mA and maximum alarm current of 500 mA total, 16 hours of standby time is available from one 3.2 A-Hr battery. A second battery in parallel doubles the standby time to 32 hours.

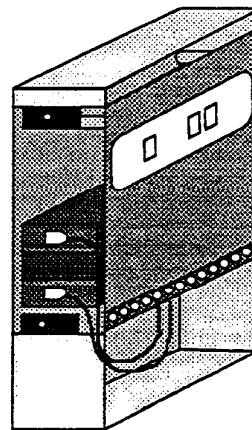

## **DIGITAL COMMUNICATOR**

The Digital Communicator allows the CPU to transmit over phone lines with Bell 103 format through an RJ-31X jack. The communications format between the CPU and Central Station is interactive (i.e.: CPU programming, system status information and other data can be viewed or changed from the Central Station.). The reporting is done by zone for Alarm, Alarm Canceled, Supervisory, Trouble, Sensor Bypass and Restorals. The communicator Pulse Dials up to 14 digits if programmed by a Central Station.

## **OPTIONAL PRODUCTS**

ITI offers numerous optional products and devices which can be connected to the CPU to enhance its versatility and make it suitable for a wide variety of security applications. Sections of this manual are dedicated to each of these products.

## **CPU INSTALLATION**

### **DETERMINE THE CPU MOUNTING LOCATION.**

- **DO** centrally locate the CPU with respect to all sensors.
- **DO** locate the CPU in an out of the way area yet easily accessible to the customer.
- **DO** locate the CPU in a heated area of the building (32° F to 95° F).
- **DO** permanently mount the CPU on a wall.
- **DO** locate the CPU near eye level so the displays can be easily viewed. Areas such as coat closets or behind the master bedroom door are good locations. Remember to leave enough room for the antennas.
- **DO** verify the availability of a 110V non-switched AC outlet for the power transformer.
- **DO** install the RJ-31X jack within 5 feet of the CPU.
- **DO** avoid locations with excessive metal, such as furnace ducts, foil insulation, pipes and electrical wiring.
- **DO** locate the CPU on the same or a higher level as most of the sensors.
- *It is recommended that the CPU display is mounted so that the display is not visible from outside the protected area.*
- **DO** install all equipment and wiring in accordance with the National Electrical code and NFPA 74 Standard (National Fire Protection Association, Battery Park, Quincy, MA 02269).



*CPU Cont.*

## LEVEL AND MOUNT THE CPU

- 1 Open any knockouts for wire feeds.
- 2 Mark the four keyhole mounting slots, and any knockout holes on the wall where the CPU is to be mounted. Keep in mind that the CPU antennas extend about 9" above the CPU cabinet.
- 3 MOUNT THE CPU SECURELY, either directly to a stud with 1-1/2" screws or, if a stud cannot be located, with toggle bolts.
- 4 The CPU is heavily protected against power surges and lightning using Metal Oxide Varistors (MOV), Spark Gaps and Transorbs.

## CPU CONNECTIONS

The instructions which follow describe CPU connections for power and digital communicator only. A variety of the other devices can be wired to the CPU. If you will be using any device hardwired to the CPU, refer to the appropriate section of this manual for connection information and wiring diagrams.

*All connections to the CPU must be made with the POWER OFF to avoid damaging the CPU.*

**NOTE:** The CPU Power-up procedure is located at the beginning of the PROGRAMMING SECTION.

**CAUTION!!! IT IS IMPORTANT TO BE FREE OF STATIC ELECTRICITY WHENEVER WORKING WITH THE CABINET DOOR OPEN. BE SURE TO DISCHARGE ANY STATIC BY FIRST TOUCHING THE CPU CABINET AND STAY IN CONTACT WITH THE CABINET WITH ONE HAND WHENEVER TOUCHING ANY COMPONENT ON THE BOARD OR USE A WRIST ATTACHED GROUND STRAP WHEN AVAILABLE.**

- 1 Insert the two antennas through the holes provided in the top of the CPU and tighten the set screws. The antennas should be vertical and clear of metal wires, coat hangers, pipes, duct work, etc.
- 2 Be sure the Master Power Switch & Programming Switch both are OFF (down).

- 3 **With the transformer unplugged and the back-up battery disconnected**, connect ALL 4 WIRES to the CPU as follows:

Transformer Terminal 1 to CPU screw Terminal 1 (DC +)  
 Transformer Terminal 2 to CPU screw Terminal 2 (GND/DC-)  
 Transformer Terminal 3 to CPU screw Terminal 3 (LINE CARRIER)  
 Transformer Terminal 4 to CPU screw Terminal 4 (AC INDICATOR)

For wire runs of 1'-15' use minimum 22 gauge wire, 16'-50' use minimum 18 gauge wire.

**Warning:** Do Not Connect to an AC Receptacle Controlled by a Switch.

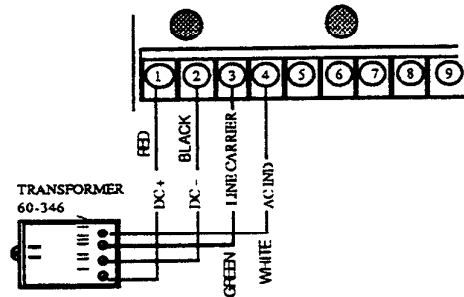

- \* **DO NOT STORE ANY EXCESS WIRE BEHIND THE CPU CIRCUIT BOARD.**
- \* **Do not power other equipment from the CPU's transformer.**

- 4 Connect the standby battery leads to the CPU. **POLARITY MUST BE OBSERVED. THE BATTERY SHOULD CHARGE TO 6.4 VOLTS DC OR ABOVE.** The CPU is designed to use only the Panasonic LCR 306P battery for standby power.

Battery + lead (red)	to	CPU screw Terminal 5 (+Batt)
Battery - lead (black)	to	CPU screw Terminal 6 (- Batt)

A second battery may be installed in the battery compartment if required. Loosen the two screws and remove the cover to gain access. The second battery must be connected in parallel (directly to the CPU terminal strip with its own leads). Replace the battery compartment cover and tighten the set screws after sliding the battery into place.

**Notice:** Test batteries at least once per year with and without AC power connected.

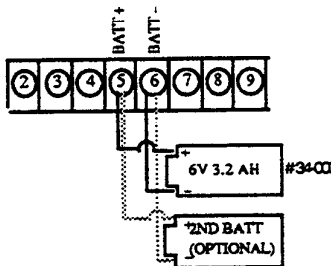

CPU Cont.

- 5 Connect the RJ-31X cord to the CPU as indicated below.

Terminal 15 (line tip)	to	RJ-31X Cord Green
Terminal 16 (phone tip)	to	RJ-31X Cord Brown
Terminal 17 (phone ring)	to	RJ-31X Cord Gray
Terminal 18 (line ring)	to	RJ-31X Cord Red

- 6 Secure the RJ-31X cord strain relief to the CPU chassis, using the screw in the lower right corner of the CPU board.

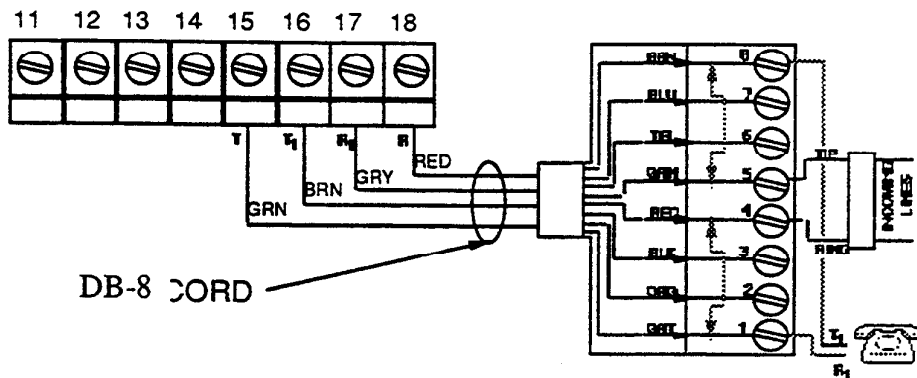

### TAMPERING THE RJ-31X JACK

By using an 8 conductor RJ-31X cord, you can tamper the cord against removal. You simply need to connect the two unused wires (orange and blue) in series with the CPU tamper switch and install a jumper in the RJ-31X jack to accomplish this.

- 1 Connect the blue and orange in series with the CPU tamper switch.
- 2 Install a jumper between screw 2 and screw 7 inside the RJ-31X jack and plug the RJ-31X cord back into the RJ-31X jack.
- 3 To test the tamper circuit, put the CPU in levels 1-7, remove the cord. This will test the tamper circuit. The CPU will go into a 92 alarm.

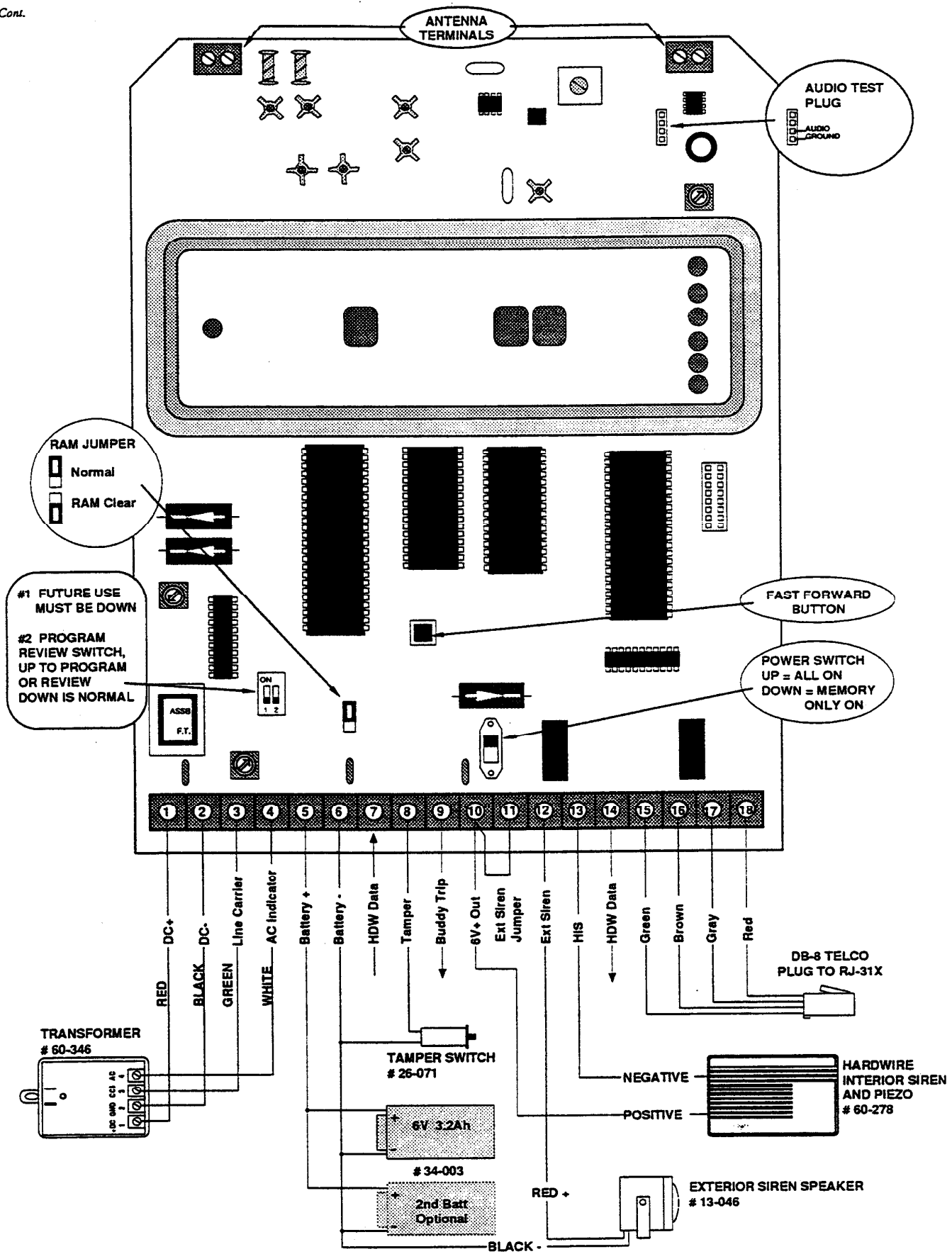

## CPU HARDWIRE TAMPER INPUT

The CPU has a Hardwire Input which is connected to a tamper switch. With the tamper switch installed, opening the door when the CPU is armed to protection levels 1-7 causes the CPU to go into audible police alarm, and report a 113 CPU TAMPER to the Central Station. Optionally, other hardware devices such as a siren tamper or RJ-31X cord tamper can be wired in series into this input. The input is set **NORMALLY CLOSED** (open on alarm) but can be re-configured to be **NORMALLY OPEN** (closed on alarm) if necessary. To change from N/C to N/O, see Optional Feature F01.

### SAMPLE CONNECTIONS

Refer to the drawings below for sample tamper connections.

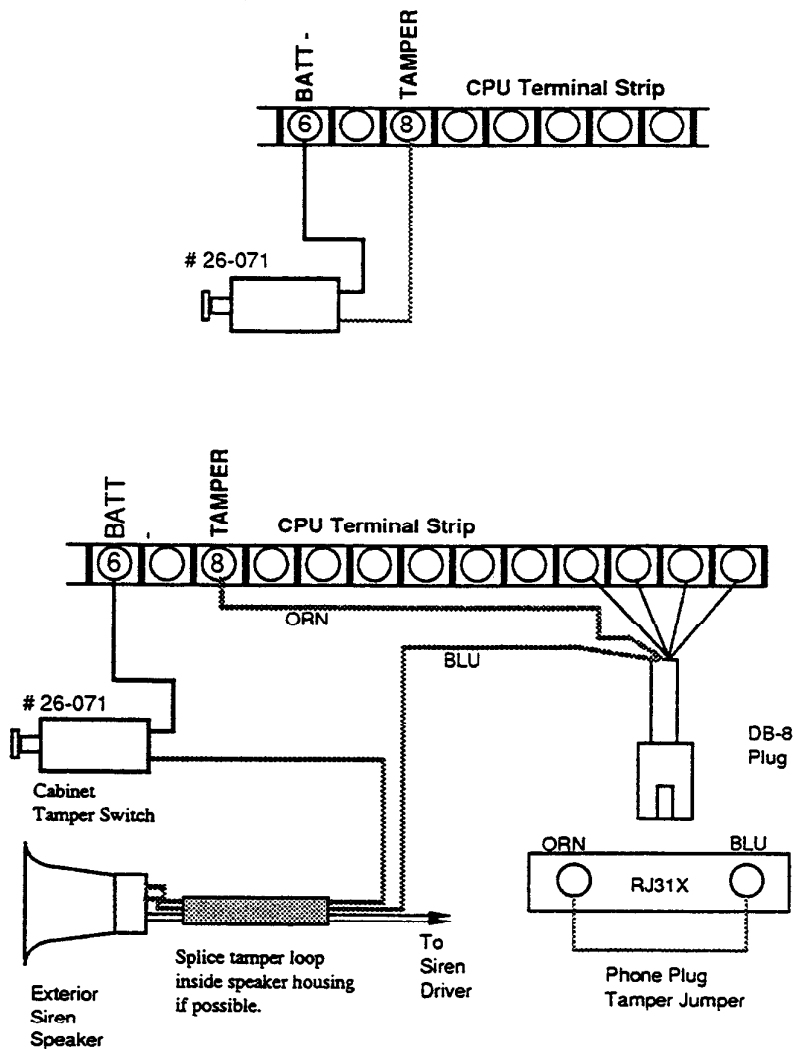

**NOTE:** In a U.L. Listed System, a U.L. listed tamper switch shall be used.

# TOUCHPADS

## WALL MOUNT WIRELESS TOUCHPAD

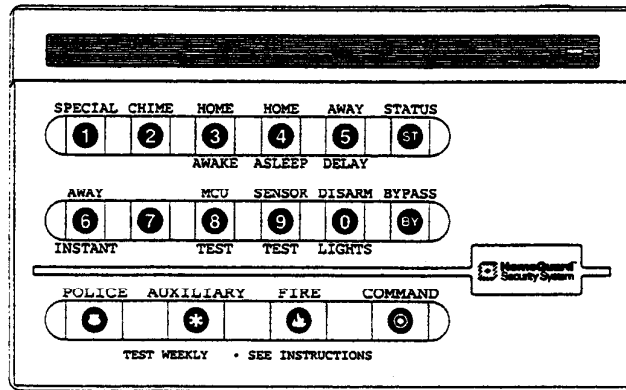

The Wireless Touchpad (WT) is used to give commands to the CPU. All arming, disarming and other signaling can be done with the WT.

When the CPU's program switch is ON, the WT becomes the installer's programming tool. (See section: PROGRAMMING)

The WT consists of two sections of touch sensitive pads, an ALARM section and a CONTROL section.

### WIRELESS TOUCHPAD - ALARM SECTION

The ALARM section is used to manually trigger an alarm in Levels 0 through 8. The three alarms that can be triggered from the WT are POLICE, AUXILIARY, and FIRE. There is a button for each alarm that must be pressed and held for three second to set off the alarm. This guards against accidental triggering of the alarms. The table below illustrates the CPU response when the two alarm buttons are pressed.

#### CPU ALARM RESPONSE

<u>BUTTON PRESSED</u>	<u>SENSOR NUMBER REPORTED</u>	<u>CPU DISPLAY</u>	<u>AUDIBLE RESPONSE</u>
FIRE	103	A3	Loud Steady tone siren
POLICE	104	A4	Loud Modulated Siren
AUXILIARY	105	A5	Low-level beeping tone

When an alarm is activated from the Wireless Touchpad, a signal is also sent to the Central Monitoring Station.

## WIRELESS TOUCHPAD - CONTROL SECTION

The CONTROL section is used to select the arming level. This section is made up of buttons 0 through 9, STATUS, BYPASS, COMMAND and LIGHTS. To properly use the CONTROL section, it is necessary to know the 4-digit Access Code (combination). The system powers up with an Access Code of 1-2-3-4.

The 4-digit Access Code must be entered before any change in arming level. For example: To arm the system to protection level 1, enter the 4 digit Access Code, then immediately press the digit 1. A single "beep" will be heard and a "1" will be displayed on the CPU's protection level display window.

*An access code with a status of LO cannot disarm to level zero (0).*

## STATUS

The STATUS button serves two purposes during normal operations:



1. To request an audible indication of the system's current protection level.
2. To activate the ALARM MEMORY and give a visual indication of any sensors that were in alarm during the previous arming period.

The table that follows outlines the audible responses for each protection level when the STATUS button is pressed.

## AUDIBLE STATUS RESPONSES

PROTECTION LEVEL	AUDIBLE RESPONSE
0 - DISARM/CANCEL	One long beep
1 - SPECIAL	One short beep
2 - CHIME	Two short beeps
3 - HOME AWAKE	Three short beeps
4 - HOME ASLEEP	Four short beeps
5 - AWAY DELAY	Five short beeps
6 - AWAY INSTANT	One long and one short beep
7 - SILENT AWAY	One long and two short beeps
8 - PHONE TEST	One long and three short beeps
9 - SENSOR TEST	One long and four short beeps

## ALARM MEMORY

The ALARM MEMORY is displayed at the CPU when the STATUS button is pressed. If an alarm occurred, the CPU will light the alarm LED, and the number of any and all sensors that had been in alarm will be displayed. The ALARM MEMORY is available for review for six hours after the system is disarmed and then it automatically clears. Selecting Level 9 will also clear the ALARM MEMORY. There is no audible indication that an alarm occurred during the previous arming period.



## BYPASS



The system will not allow immediate selection of a new protection level unless all sensors active in that new level are closed or restored. Instead of arming to the new level, the system will generate two-tone "protest" beeps. The display will show which sensor(s) are open. The system can be "force armed" by using the BYPASS button.

## INDIRECT BYPASSING

On a nice spring evening a customer could protect the house by arming to Level 3, and also leave his master bedroom window (for example, sensor 42) open. The BYPASS button is used to accomplish this. First, all doors and windows must be closed except the bedroom window, which is left open. Next, the system is armed to Level 3. When the protest beeps are heard, press the BYPASS button immediately. This will cause the system to arm to Level 3 while bypassing the bedroom window, number 42.

This bypass procedure can be used to bypass more than one sensor at a time. It is recommended that the display always be checked to be sure the correct sensor or sensors have been bypassed.

*Note: This Bypass procedure shall not be used in a U.L. listed installation.*

## AUTOMATIC BYPASSING

If the customer attempts to arm the system with a sensor or sensors in the non-restore condition, the system will generate protest beeps. Should the customer mistake the protest beeps for the exit delay beeps and leave the premises unsecured, the system will automatically arm to the protection level the customer attempted to select after 3 minutes. Any sensors which were causing the CPU to protest (: all open sensors) will automatically be bypassed. The CPU will report an "110 FORCE ARM AUTO" to the Central Station.

## DIRECT BYPASSING

Another way to BYPASS is called Direct Bypassing. To use direct bypassing, select a particular sensor number that you want bypassed. Then enter the 4 digit Access Code + BYPASS + the sensor number.

To bypass the same bedroom window (42) from the example above, arm the system to Level 3 (Access Code + 3). Next, enter the Access Code + BYPASS + 42. If properly bypassed, 42 will show in the sensor number window and the Bypass LED will be on. An Access Code with a status of HI must be used when direct bypassing. The Temporary Access Code will not work for this feature. This will leave the CPU in protection Level 3 but bypass sensor number 42. All other sensors active in Level 3 will still be armed.

Using direct bypassing, the customer can bypass any sensor number (except sensors programmed for fire). Multiple sensors must be bypassed one at a time. With each direct bypassing command, the exit delay timer is reset to allow the user time to exit. With either method of sensor bypassing, keep in mind that changing the protection level clears the bypass. Thus, the customer must repeat the bypassing steps if they change protection levels and still want bypassed sensors. Below is a summary of the differences between direct and indirect bypassing.

<u>INDIRECT BYPASSING</u>	<u>DIRECT BYPASSING</u>
Primary, Low Level, <u>or</u> Temporary Access Codes can be used to bypass sensors	Only the primary Access Code or High Level Access Codes can be used to <u>direct bypass sensors.</u>
Sensors to be bypassed <u>must</u> be open or activated.	Sensors to be bypassed can be <u>either open or closed.</u>
Can only bypass those sensors which can be left <u>OPEN (doors and windows).</u>	Any* sensor number can be open bypassed. <u>*Not fire sensors.</u>
Can bypass as many sensors as are open, all at once.	Can only bypass one sensor number at a time.

### LIGHTS

Turns lights connected to X-10 Modules on or off. Toggles lights.

### COMMAND

Allows the user to arm without entering an access code. Two keystrokes are all that is needed to arm to a higher protection level. Can only be used to increase protection.  
Cannot be used if an alarm has occurred or during an entry delay.

Pressing the command button followed by a higher protection level will arm the panel to that level. The access code is needed to disarm or reduce the protection level at all times.

## INSTALLING THE WIRELESS TOUCHPAD

Most of the time the Touchpad will be left on its mounting bracket which can be permanently secured to a wall. It can also be lifted off its bracket for portability. Typical locations are near exterior doors and in or near the master bedroom.

### INSTALLATION CONSIDERATIONS

- **DO** locate the Touchpad in a convenient location offering easy access for exit and entry control.
- **DO** avoid metallic mounting surfaces such as foil wallpaper, steel frames, mirrored walls, etc.
- **DO** test the Touchpad before you permanently mount it.
- **DO** try to keep the Touchpad within 100 feet of the CPU.

Although the open air range of sensors can be over 500 feet, the installation environment will influence this distance. The 100 foot distance recommendation is given as a starting guideline. In your actual installation, transmission range may be much greater.

- **DON'T** install Touchpad in areas with excessive metal or electrical wiring, such as furnace/utility rooms, etc.
- **DON'T** attach mounting bracket with two sided tape.
- **DON'T** locate Touchpad where it is likely to be exposed to moisture.
- **DON'T** install the Touchpad in a location where the room temperature will exceed the Touchpad's operating limits 10° F to 140° F.
- **DON'T** install Touchpad closer than 3 feet to CPU.

## INSTALLATION OF THE WIRELESS TOUCHPAD

- 1 Secure the mounting bracket to the wall, narrow part up, hollow side toward you.

**NOTE:** The mounting bracket is not centered on the back of the Touchpad, it is off to one side. This must be taken into account when the Touchpad is to be centered between two objects.

- 2 A good height for the Touchpad is about 5 feet from the floor.
- 3 Mount securely, use molly bolts or plastic anchors if mounting on plaster.
- 4 Hang the Touchpad on the mounting bracket and be sure it is level.

## HANDHELD WIRELESS TOUCHPAD (HHWT) 60-348-10-95-SPL

The Handheld Wireless Touchpad is a light weight portable pocket-size plastic enclosed touchpad. The Handheld Wireless Touchpad is used to arm and disarm the CPU and can also be used to perform some programming functions. The Status and Bypass, Command buttons, work the same as on the Alpha Touchpad. Estimated battery life is 5 to 8 years.

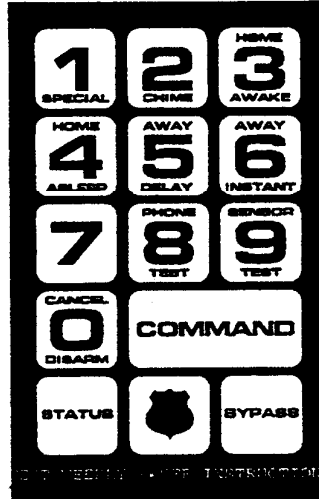

### ALARM KEYS

The ALARM section is used to manually trigger an alarm in Levels 0 through 8. The Police Emergency alarm can be triggered from the touchpad by pressing the POLICE, button for three seconds or by pressing the command button and then the Police button. This guards against accidental triggering of the alarms. The table below illustrates the CPU response when the alarm buttons are pressed.

### CPU ALARM RESPONSE

BUTTON PRESSED	SENSOR NUMBER REPORTED	CPU DISPLAY	AUDIBLE RESPONSE
POLICE (hold three seconds)	104	A4	Loud modulated siren

When an alarm is activated from the Wireless Touchpad, a signal is also sent to the Central Monitoring Station.

Try to keep the Touchpad within 100 feet of the CPU.

Although the open air range of sensors can be over 500 feet, the installation environment will influence this distance. The 100 foot distance recommendation is given as a starting guideline. In your actual installation, transmission range may be much greater.

# SENSORS

## DOOR/WINDOW SENSOR (DWS) 60-362 (white)

These sensors are designed to be installed on doors, windows, gun cabinets, or anything else that opens and closes. Each contains two built-in magnetic reed switches and is designed to go into alarm by moving the supplied magnet away from the sensors reed switches. The sensor offers screw terminals that will accept normally open or normally closed hardwire devices (switches, carpet mats, etc.)

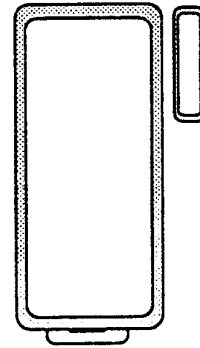

A Door/Window Sensor will transmit signals during normal operation. When a door is opened, a "VIOLATION" signal is sent to the CPU. When the door is closed a "RESTORE" signal is transmitted. *These signals are sent whether the system is armed or not.* If an attempt is made to arm the system to a level in which the sensor is active and that sensor is in a violated state (door open, for example), the CPU will "protest" by emitting a series of continuous beeps and refuse to arm to the desired level. The number of the violated sensor will also be displayed on the CPU's LED display. The system can be armed when all of the sensors used at a particular protection level are in the "RESTORE" condition, or, if the user deliberately "BYPASSES" one or more sensors.

**BATTERY POWER** -- The Door/Window Sensor is powered by a 3.5 VDC Lithium battery. The battery is monitored. Under normal circumstances, the battery should last 5 to 8 years.

**TEMPERATURE RANGE** -- 10° F to 120° F

**TAMPER SWITCH** -- Door/Window Sensors contain a built-in tamper switch. Removing the sensor cover causes the sensor to transmit a "TAMPER" signal to the CPU. If the CPU is armed to a protection level in which the tampered sensor is active, an alarm will occur. If the tampered sensor is not active in that arming level, the CPU will not go into immediate alarm, but will remember the TAMPER signal and "PROTEST" (as if the sensor had been left open) the next time an attempt is made to arm the system. The CPU will still "PROTEST" until a "RESTORE" signal is heard from the sensor. This can be accomplished by opening, then closing the protected door or window.

**IMPORTANT** -- When working on Door/Window Sensors, be sure to select a protection level in which the sensor, whose cover you are removing, is disarmed before opening sensors. For 24 hour sensors or if F15 is active, this will mean selecting protection level 9.

**NOTE:** The tamper feature cannot be disabled.

### SUPERVISORY INDICATIONS

Every 69 minutes sensors send a supervisory signal to the CPU. If no signals have been heard from a particular sensor after 12 hours, the number of the problem sensor is displayed and the "SUPERVISORY" LED is lit. The problem sensor will be reported to the Central Station.

## INSTALLATION CONSIDERATIONS

- **DON'T** mount within 5 inches of the floor on a door to avoid damage.
- **DON'T** mount sensors or magnets on any metallic surfaces such as metal doors or foil wallpaper. If you must, then use spacers to keep sensors and magnets away from the metal.
- **DON'T** install transmitters closer than 3 feet to CPU.
- **DO** mount magnet on one door, sensor on the other for double door installation.
- **DO** mount sensors with screws, not two-sided tape.
- **DO** try to keep all transmitters within 100 feet of the CPU.

Although the open air range of transmitters can be over 500 feet, the installation environment will influence this distance. The 100 foot distance recommendation is given as a starting guideline. In your actual installation, transmission range may be much greater.

- **DO** avoid areas with excessive metal or electrical wiring, such as furnace/utility rooms.
- **DO** avoid locating transmitters where they are likely to be exposed to moisture.
- **DO** install the sensor in a location where the temperature will not exceed the sensors operating limits of 10° F to 120° F.

## PREPARATION BEFORE INSTALLATION

- 1 Remove the sensor cover by pressing on the cover end to release the tab on the cover from the slot in the sensor base.

**CAUTION!!!** It is important for you to be free of all static electricity when handling transmitters. Touch something metal, before handling the transmitter circuit board. Handle only by the edges. Never set the circuit board on any metallic surface.

- 2 Carefully remove the circuit board by pulling back on the tab and lifting the battery holder; or gently flex the plastic sensor base to release the circuit board.

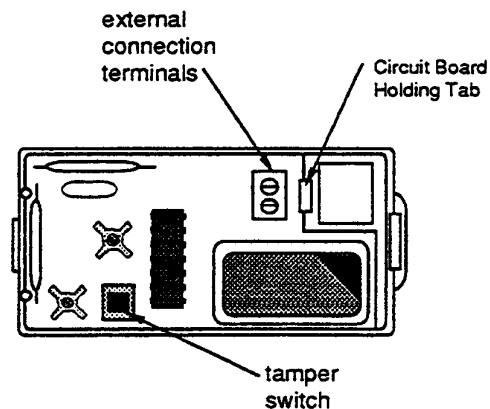

## MOUNT THE SENSOR BASE

- 1 Two screw holes are provided, one is enlarged to allow for sensor alignment.

*NOTE:* The sensor base has markings which indicate the position of the reed switches when the circuit board is reinstalled. Use the markings to aid in your alignment.

- 2 Use #6 flathead screws when mounting the sensor. Optionally two small holes are provided to allow for mounting with 18 gauge wire nails.

## MOUNTING THE MAGNET

- 1 Mount magnet base within 3/8" of the sensor's base, centered on the notch or tab. Use two #6 x 1/2" flathead screws or #18 x 1/2" wire nails. A brad driver works well if using nails.

- 2 Be sure magnet won't interfere with door or window opening.

- 3 Do not use two sided tape to mount magnet.

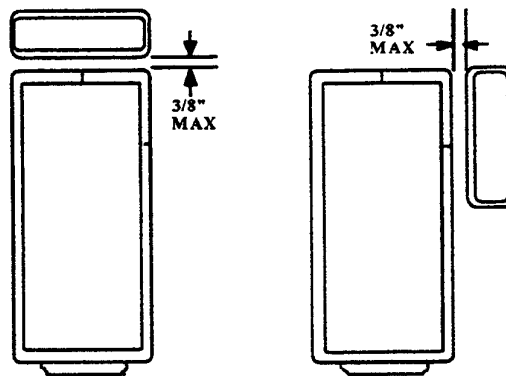

## REPLACE THE CIRCUIT BOARD.

## REPLACE THE SENSOR COVER.

## INTERFACING REMOTE DEVICES TO A DOOR/WINDOW SENSOR

The Door/Window Sensor can be connected to either Normally Open (closes on alarm) or Normally Closed (open on alarm) devices. The configuration of the sensor is a programmable option selected when programming. See Programming section.

Multiple NORMALLY CLOSED devices would be wired in SERIES all in the same line.

Multiple NORMALLY OPEN devices would be wired in PARALLEL all to the same two screw terminals.

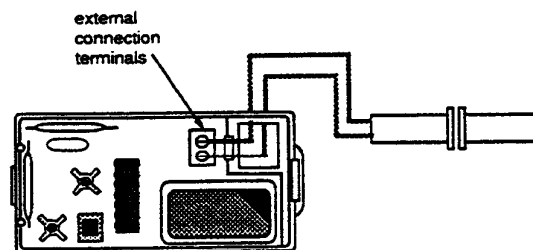

*Note: The normally closed configuration must be used in U.L. listed installations.*



## INTERFACING CONSIDERATIONS

**Note:** Use recognized limited energy cable to all initiating, indicating and supplementary devices.

- **DO** make sure the device connected to the sensor is a hermetically sealed type. Such as a sealed reed switch. **DON'T** use mechanical switches connected to a DWS.
- **DO** make sure the device supplies a minimum 100 millisecond open or closure on alarm. This is important! **DON'T** attempt to connect fast pulse devices such as Window Bugs to a DWS.
- **DON'T** exceed 6 feet of wire in any wire run if using untwisted wire.
- **DO** use stranded wire, not solid core wire. **DON'T** exceed 25 feet of 22 AWG (minimum) wire in any wire run if using twisted wire.
- **DON'T** connect more than 5 switches to a DWS. Fewer than 5 is preferred.
- **DON'T** connect more than 1 alarm screen to a DWS.
- **DON'T** run wires within 18" of electrical wiring. Never run parallel to electrical wires, cross them at a 90 degree angle.

**NOTICE:** *The GlasTrak™ GSU 2000 Glass Break detector will not function with SYSTEM equipment.*

## SMOKE SENSOR 60-352

The Smoke Sensor is a Photo-Electric type that contains its own Alarm Horn and Low Battery Annunciator. It has an output that will trip a special transmitter already built into the detector. The built-in alarm horn will sound as long as smoke remains in the Smoke Sensor. It is powered by two 9 Volt Alkaline batteries. Both of the 9 volt batteries are monitored. The Smoke Sensor's own low battery annunciator will make a short "beep" sound every minute until the batteries are replaced.

Refer to the Owners Manual included with each Smoke Sensor for detailed information. Also, be sure to give the Smoke Sensor's Owners Manual to the purchaser of the system after the installation is complete.

Additional information on Household Fire Warning is available at nominal cost from: The National Fire Protection Association, Battery Mark Park, Quincy, MA 02269. Request NFPA Standard 74.

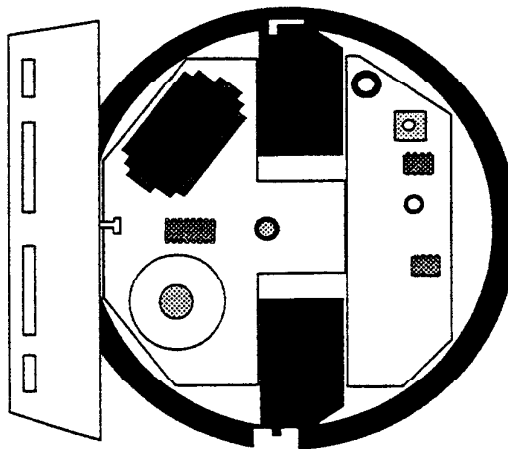

### **SUPERVISORY INDICATIONS**

Every 69 minutes sensors send a supervisory signal to the CPU. If no signals have been heard from a particular sensor after 12 hours, the number of the problem sensor is displayed and the "SUPERVISORY" LED is lit. The problem sensor will be reported to the Central Station.

### **INSTALLATION CONSIDERATIONS**

While it is not possible to get too specific about Smoke Sensor location (since each residence has different design requirements), there are some guidelines that can be followed. Refer to the sensor's Owners Manual for detailed information on sensor location. Some additional hints appear on the next page:

- **DO** determine the best locations for each Smoke Sensor so as to optimize early detection, and maintain accessible escape routes out of the building.
- **DO** locate a Smoke Sensor at the bottom of the basement stairwell(s). For other levels, it is usually best to locate Smoke Sensors at the top of the stairwell.
- **DO** locate a Smoke Sensor in any hallway servicing bedrooms. For maximum protection, place a Smoke Sensor inside each bedroom, especially smokers bedrooms or bedrooms where electric blankets or other electrical devices are used.

*Smoke Sensor Cont.*

- **DO** mount sensors on ceilings whenever possible. Make sure that the sensor is no closer than 4 inches to any wall. For wall mounting, make sure that the nearest edge of the detector is at least 4" and no more than 6" from the ceiling.
- **DO** avoid mounting sensors on any slanted surface.
- **DO** try to keep the Smoke Sensor within 100 feet of the CPU.

Although the open air range of transmitters can be over 500 feet, the installation environment will influence this distance. The 100 foot distance recommendation is given as a starting guideline. In your actual installation, transmission range may be much greater.

- **DO** check for areas of the installation which may inhibit the Smoke Sensors radio signals from reaching the CPU. This would include areas with excessive metallic surfaces or electrical wiring.

NOTE: Ceiling mounted smoke detectors should be located in the center of the room or hall, or not less than 4 inches from any wall. When the detector is mounted on a wall, the top of the detector should be 4 to 12 inches from the ceiling.

NOTE: Do not install smoke detectors where normal ambient temperatures are above 100 F or below 40 F. Also do not locate detectors in front of AC/Heat registers or other locations where normal air circulation will keep smoke from entering the detector.

NOTE: Additional information on household fire warning is available at nominal cost from: The National Fire Protection Association, Batterymarch Park, Quincy, MA 02269. Request Standard No. NFPA74.

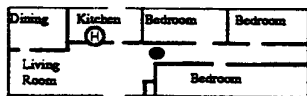

Smoke detectors should be located between the sleeping area and the rest of the family living unit.

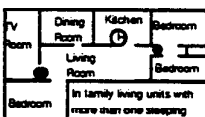

In family living units with more than one sleeping area, a smoke detector should be located at each area.

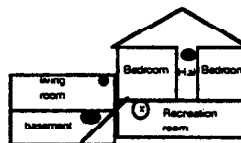

Required smoke detector ●  
Indicates smoke detector is optional if door is not provided between ceiling and recreation rooms.  
Heat Detector ⊕

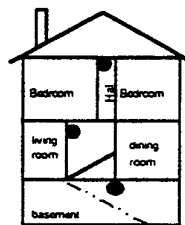

A smoke detector should be located on each level.

**MOUNTING THE SMOKE SENSOR:**

- 1 Remove the sensor's mounting bracket to screw onto mounting surface.
- 2 Mount directly onto wood surfaces using 1-1/2" wood screws. If mounting onto plaster or dry wall use molly bolts or appropriate plaster anchors.
- 3 Re-attach sensor onto the mounting bracket.

## TESTING THE SMOKE SENSOR

The following procedure can be used for testing. It can be done now or with the final testing of the entire system.

- 1 Verify that the CPU is programmed with the sensor number(s) of the Smoke Sensor(s) being tested. If not, program the CPU as described in the Programming Section.
- 2 Arm the CPU to protection Level 9 (SENSOR TEST). The sensor numbers of the Smoke Sensors being tested should scroll in the CPU display window.
- 3 Press and hold the test button on the Smoke Sensor for *20 to 30 seconds* until the alarm horn sounds and the red light glows steadily.
- 4 Check the scrolling sensor numbers on the CPU. The sensor's number should no longer be displayed.
- 5 It is recommended that the Smoke Sensor be tested as part of the system by disarming to Level 0 and pressing the test buttons on the sensors. Sirens should sound with a steady loud tone. The Smoke Sensor's built-in alarm will stop a few seconds after the test button is released. Rearm to level 0 to stop the CPU siren. If the phone jack is plugged in, the Central Station will receive the alarm. The Central Station must be informed before testing begins.

**NOTE:** The alarm system sirens and the Smoke Sensor's built-in siren will BOTH sound when smoke is detected. The CPU alarm is canceled from the Touchpad (Access Code + 0) and the sensor's alarm is canceled by clearing the smoke from the detector.

## PASSIVE INFRARED MOTION SENSOR 60-356

A Passive Infrared (PIR) Sensor is designed to detect movement in the interior of an enclosed structure. The PIR Sensor adapts to the environment in which it is placed, and continually gathers information about that area. Any change in this stable environment caused by an object which emits a different degree of infrared heat energy is sensed and an alarm is generated.

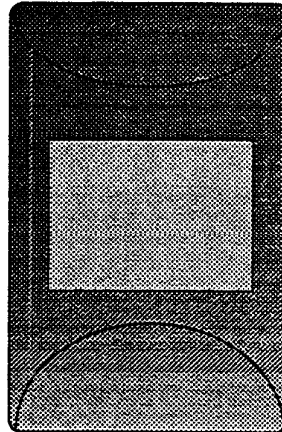

When a PIR detects thermal movement, a "VIOLATION" signal is sent to the CPU. These signals are sent whether the CPU is armed or disarmed. A PIR cannot prevent the system from arming.

PIR sensors are SUPERVISED, that is they send a check in signal to the CPU every 69 minutes just like the DWS.

The Model 60-356 comes complete from ITI with a wireless transmitter. The transmitter is compatible with the "learn mode" CPU.

**BATTERY POWER:** The PIR uses a 3.5 VDC Lithium battery. Under normal conditions, this battery will last 3 years. Whenever the PIR transmits to the CPU, it reports its battery condition. When the batteries begin to get low, the CPU will display and report the number of the PIR with the low battery. When this happens, replace the battery.

**TEMPERATURE RANGE:** 10°F TO 120°F

**TEST FEATURES:** A fast-reset LED walk light is selected by moving a jumper on the circuit board to the LED MODE. When in this mode, the PIR's LED indicates when the unit detects movement. When in the LED mode, the PIR will transmit every time the LED lights. There must be 10 seconds of inactivity between each test. *DO NOT FORGET TO RETURN THE JUMPER TO THE RADIO MODE.*

**TRANSMITTER LOCKOUT:** In the Radio Mode, the transmitter will transmit once, then "lockout" (i.e. not transmit again) unless the detector sees no motion for at least 3 minutes. Any movement prior to 3 undisturbed minutes causes this timer to reset and another 3 undisturbed minutes would be required before the unit will transmit.

## INSTALLATION CONSIDERATIONS

- **REFERENCE POINT** - Mount the PIR so there is a reference point (such as a wall) at the end of its pattern.
- **FOR BEST DETECTION** - Mount these sensors so an intruder will most likely walk **ACROSS** the beams.
- **PERMANENTLY MOUNT THE PIR** - Do not simply set it on a shelf without screwing it down because the customer might move it and change its field of view.
- **MOUNTING HEIGHT** - Mount at between 5 and 8 feet high for best detection.
- **PETS** - If pets will be allowed in the PIR's field of view, you must use the optional PIR lens for Pet Patterns. The down finger zones are eliminated; thus, making it possible for pets to have access to the protected area.
- **MASK OFF ZONES** - To provide the desired coverage.
- **LOCATION** - Even though these PIR's are highly immune to false alarms, you should follow these standard Passive Infrared locating guidelines:
  - \* Don't locate in direct sunlight.
  - \* Don't aim at air conditioners, heat vents, wood stoves, fireplaces, etc.
  - \* Don't aim at moving objects (curtains, etc).
  - \* Don't aim at solar heated walls or uninsulated metal walls.
  - \* Do attempt to mount on an outside wall facing in.
  - \* Do mount on a surface which is rigid and free from vibration.
- As with any radio transmitter, avoid mounting on or near large metal objects such as a heat duct or foil wallpaper.

## **LENS REPLACEMENT**

See the DS923 Installation Instructions included to replace lenses.

Many lens options are available for the DS923 PIR. If you require a different detection pattern for your application, select the appropriate lens from the DS923 installation instructions. A cross-reference list for part numbers follows:

<u>DS Part #.</u>	<u>ITI Part #.</u>
OLB92	13-166 (70' barrier lens)
OLP92	13-167 (78° 35' pet lens)
OLWA92	13-168 (110° wide angle lens)

PIR Cont.

## INSTALLATION

Install the PIR according to the Installation Instructions included with the DS923 detector.

## TRANSMITTER INSTALLATION

The PIR comes to you complete with a transmitter pre-installed. This transmitter is for use with the CPU. The CPU will "learn" of the presence of a PIR in its system by simply tripping the tamper on the PIR (remove the cover). See Programming section for more details.

The transmitter circuit board connects to the PIR circuit board by a 4 pin connector on the top of the PIR circuit board. You must remove the vertical adjustment screw on the PIR circuit board if you wish to remove the PIR or transmitter circuit board. You will notice the guide rails on either side of the PIR base that holds the semicircular transmitter board. To remove, simply slide the transmitter board away from the PIR board. To reinstall, position the transmitters connector pins into the PIR boards connector and slide on. When reinstalling, take note that the transmitter circuit board will have a fairly tight fit in the PIR case. If you have installed each board and the PIR case cover does not close easily, please check the position of both circuit boards.

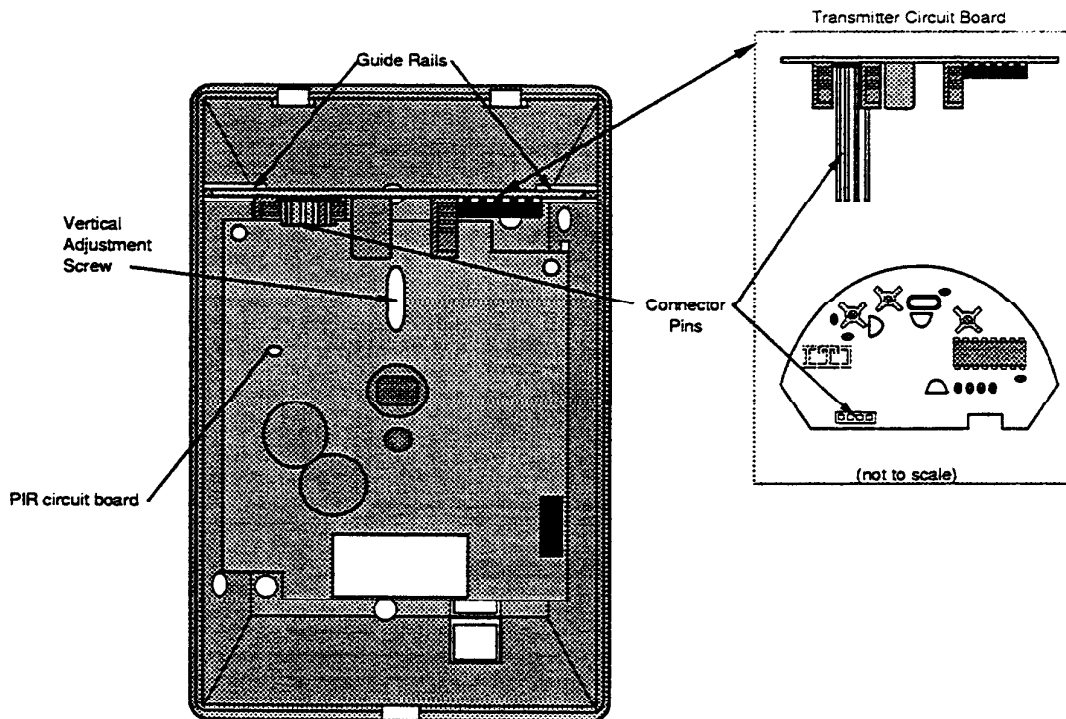

# SIRENS

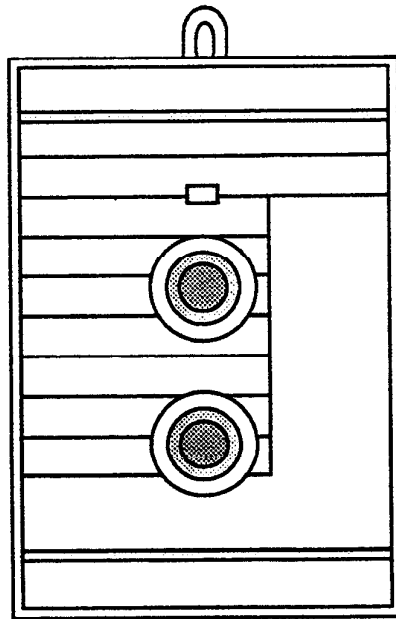
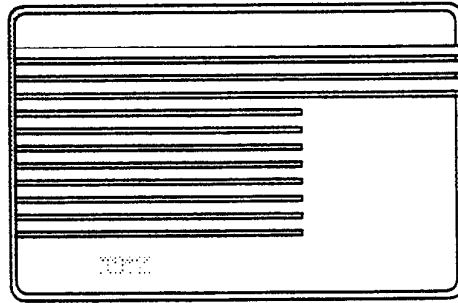



## SIRENS

The CPU initiates a variety of alarm and system status sounds. There are several types of sirens available. Both alarm siren sounds and status "beeps" can be made to sound throughout the installation site.

### INTERIOR AND EXTERIOR SOUNDS

POLICE SIREN - loud intermittent tone siren sound.

FIRE SIREN - loud steady tone siren sound.

### INTERIOR SOUNDS ONLY

AUXILIARY SOUNDS - low volume, on-off on-off beeping.

STATUS SOUNDS - low volume beeps which indicate the CPU's current protection level.

PROTEST BEEP - low volume rhythmic two-tone beeping sound when an arming attempt is made which indicates a Trouble or Supervisory condition or that a sensor is open.

TROUBLE OR SUPERVISORY BEEPS - Six quick low volume beeps repeated every sixty (60) seconds. Occurs as an automatic indicator if a trouble or supervisory condition exists and no change occurred in arming level for 10 hours.

CHIME BEEP - a pair of low volume tone which indicates a perimeter sensor has been opened and the CPU is armed to protection level 2.

SENSOR TEST SOUND - loud single tone or series of tones heard when testing sensors in protection level 9.

EXIT DELAY SOUNDS - Low volume status sounds which indicate the beginning of the Exit Delay Time when levels 3 or 5 are selected. Can be programmed to sound repeatedly for the duration of the Exit Delay Time by programming F00 into the CPU.

ENTRY DELAY SOUNDS - Low volume repeated status sounds which indicate that the Entry Delay Time is in progress.

## HARDWIRE INTERIOR SIREN AND PIEZO 60-278

The Interior Siren and Piezo is a combination unit that produces both low volume status sounds and high volume siren sounds. It is located in areas where the status and siren sounds need to be heard. Each unit draws 75 milliamps of current in alarm. It contains three piezo sirens that can deliver a 85 dB siren level in high level alarm. The trouble sound current draw is approximately 12 mA.

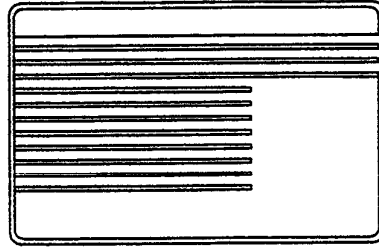

### APPLICATION CONSIDERATIONS

- The Hardwire Interior Siren and Piezo can be mounted in any location where the status sounds need to be heard.
- The number of sirens that can be installed depends on what other devices are being powered from the CPU. The total current available for all devices powered from the CPU is 500 mA.

### INSTALLATION INSTRUCTIONS

- 1 Using 22 gauge or greater, 4 conductor stranded wire, run cable from the CPU to the siren location. Note: The CPU should be OFF when connecting the siren/piezo wires.
- 2 Remove the front cover of the siren by removing the 2 bottom screws. Next, remove the 4 screws that secure the piezo assembly, and pull the piezo assembly off the base.
- 3 Feed the cable through the circular cut-out in the back of the base. Two mounting holes are provided to mount the base to the wall with the proper anchors and screws.
- 4 Resecure the piezo assembly to the base.
- 5 Connect the 2 wires from the double piezo board to the 2 left screws, and the single piezo wires to the 2 right screws.
- 6 Follow the wiring diagram for proper terminals. Note: the double piezos are activated for fire and burglary alarms only. The single piezo activates for both status and alarm sounds.
- 7 Install a jumper between CPU Terminals 10 and 11. The double piezos will not activate if this jumper is not in place.

**Note:** If you are using more than 1 Hardwire Interior Siren and Piezo, the connections to the piezos must be in parallel with polarity observed in order to maintain the siren volume.

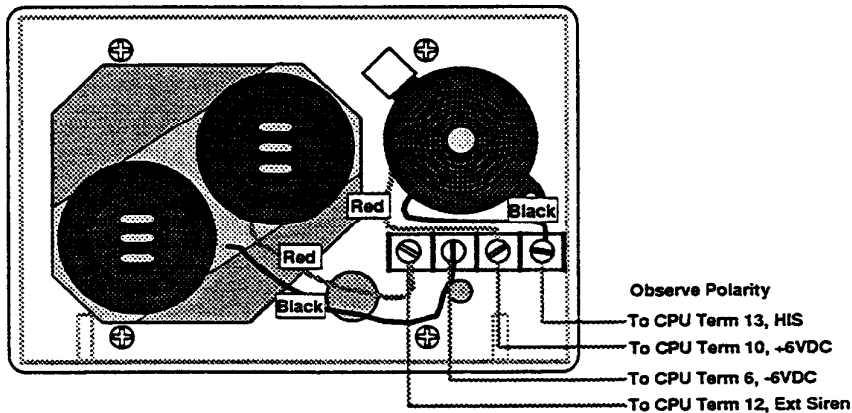

## HARDWIRE INTERIOR SIREN (HIS) 60-136

A Hardwire Interior Siren (HIS) is available for the system. Up to 3 can be wired to the CPU using 2 conductor wire. Standby power is provided by the CPU. The total number of HIS installed, is based on the maximum alarm current rating of 500 mA total for the CPU. Each HIS draws approximately 50 mA.

### HARDWIRE INTERIOR SIREN SOUND OPTIONS

The HIS can produce alarm or alarm and status sounds. There is an "F" feature that determines which sounds the HIS will produce. With F11 programmed into the CPU memory, the HIS will produce ONLY the emergency sounds. You would program in F11 if a HIS was, for example, placed in a child's bedroom where emergency sounds were wanted, but status sounds were not. With F11 not in the CPU memory, the HIS will produce emergency sounds and the various status beeps. The CPU powers up without F11 in its memory.

To add optional feature number F11 to the CPU memory, see the Programming Section.

### HARDWIRE INTERIOR SIREN CONNECTIONS

- Connect POSITIVE on the HIS to SCREW 10 (+OUT) of the CPU terminal strip.
- Connect NEGATIVE on the HIS to SCREW 13 (HIS) of the CPU terminal strip.
- Multiple Hardwire Interior Sirens would be connected in parallel.
- WARNING - Do not store any excess siren wires behind the circuit board.

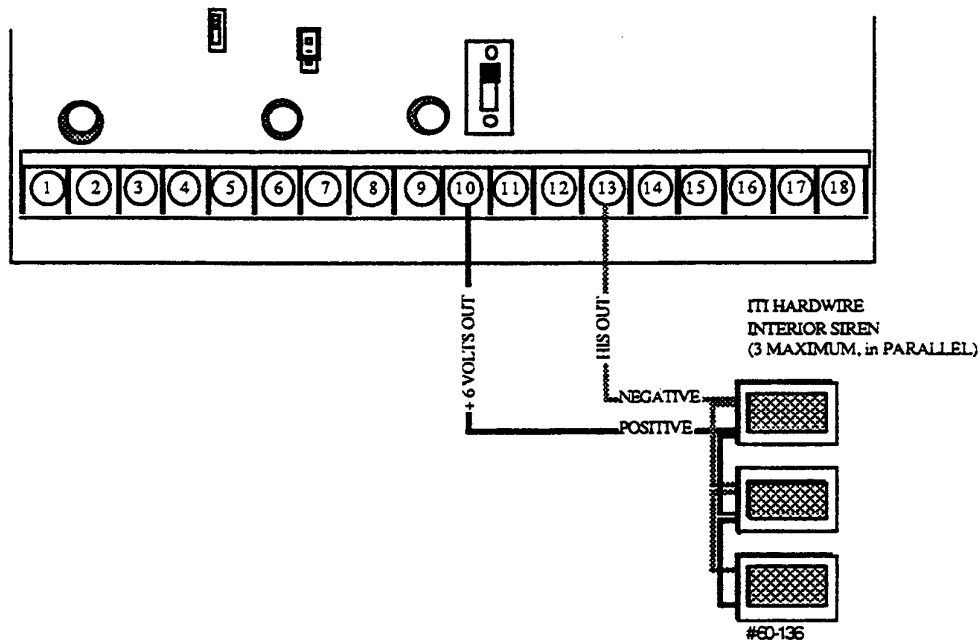

## HARDWIRE EXTERIOR SIREN 13-046

The Hardwire Exterior Siren must be hardwired to the CPU. Only full volume sounds (police and fire emergency) will be heard from the exterior sirens. The current draw of the siren driver speaker combination should not exceed 500 mA.

### HARDWIRE EXTERIOR SIREN CONNECTIONS

**WARNING:** Be sure you fully understand the wiring connections below. Failure to follow instructions may result in blown fuses and/or may permanently damage the CPU circuit board or your siren.

- 1 To provide DC power to the exterior siren relay, connect a jumper from screw 10 to screw 11 on the CPU.
- 2 Connect the RED LEAD to screw 12.
- 3 Connect the BLACK LEAD to screw 6.

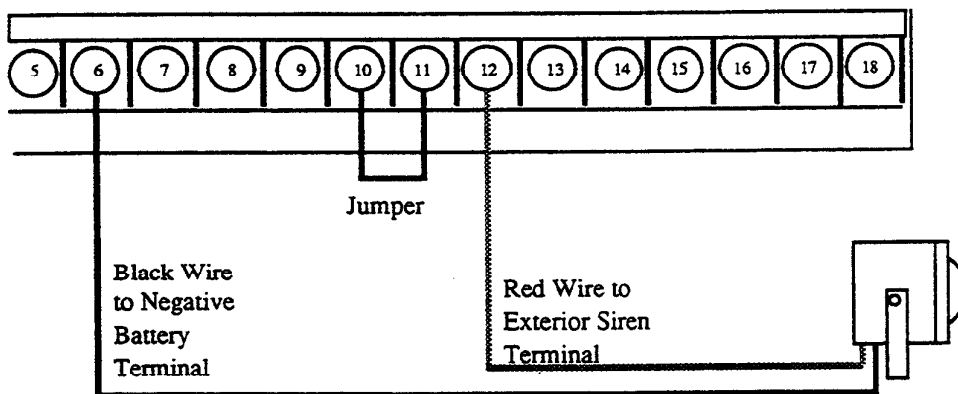

**REMEMBER:** Do not store any excess siren wires behind the CPU circuit board.

**NOTE:** Exterior Sirens will be delayed for 15 seconds when Optional Feature F02 is set. See Programming Section.

## WIRELESS INTERIOR SIREN (WIS) 60-353

The Wireless Interior Siren (WIS) is used as a siren/annunciator in areas of the installation where the CPU's siren and status sounds need to be heard. Any number can be installed and no wiring to the CPU is required. The WIS is simply plugged into a live, non-switched, 110 volt AC wall outlet. The WIS receives its signals from the CPU over the AC power line in the house. The WIS also contains a 9 volt alkaline or optional rechargeable NiCad backup battery to supply power in the event of an AC power failure.

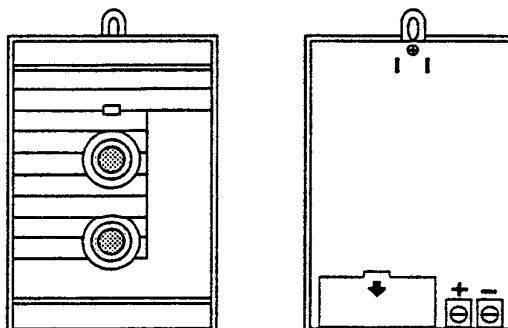

The battery will supply at least 4 hours of standby power and will also provide 85 dB minimum sound level output for at least 4 minutes. If the backup battery becomes low, the WIS will beep every 60 seconds until the battery is replaced or fails. The WIS also has screw terminals which are used to connect another siren. The terminals provide 6 volts DC and 100 mA maximum current.

The Wireless Interior Siren (WIS) is used as a siren/annunciator in areas of the installation where the CPU's siren and status sounds need to be heard. Any number can be installed and no wiring to the CPU is required. The WIS is simply plugged into a live, non-switched, 110 volt AC wall outlet. The WIS receives its signals from the CPU over the AC power line in the house. The WIS also contains a 9 volt alkaline or optional rechargeable NiCad backup battery to supply power in the event of an AC power failure. The battery will supply at least 4 hours of standby power and will also provide 85 dB minimum sound level output for at least 4 minutes. If the backup battery becomes low, the WIS will beep every 60 seconds until the battery is replaced or fails. The WIS also has screw terminals which are used to connect another siren. The terminals provide 6 volts DC and 100 mA maximum current.

### WIS DIP SWITCHES OPTIONAL FEATURES

The Wireless Interior Siren has three DIP switches located in the battery compartment which allow you to modify the operation of the WIS to fit the needs of the installation.

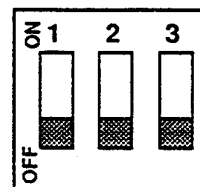

**SWITCH 1** This DIP switch allows either an alkaline or NiCad battery to be used as the battery back-up.

If **SWITCH 1** is **OFF**, an alkaline battery must be used.

If **SWITCH 1** is **ON**, a 1 mA trickle charge is applied to the battery terminals to charge an optional NiCad battery.

**CAUTION:** NEVER have Switch 1 ON if you will be using an alkaline battery. Alkaline batteries may leak or explode if recharged.

**SWITCH 2** This DIP switch allows the choice of either High Level Alarm sounds only or all Alarm and Status sounds from the WIS.

SWITCH 2 OFF, all Alarm and Status beeps will sound from the WIS.

SWITCH 2 ON, only High Level Alarm (Police and Fire) will sound from the WIS.

**SWITCH 3** This controls whether a 15 second delay will be applied to a siren wired to the terminals on the back of the WIS.

SWITCH 3 OFF, the siren attached to the terminals will activate at the same time as the WIS.

SWITCH 3 ON, the siren attached to the terminals will be delayed for 15 seconds before sounding.

**NOTE:** The siren delay on the WIS is independent of the CPU Optional Feature F02. However to avoid any confusion, it is recommended that if F02 has been programmed into the CPU, then SWITCH 3 should also be in the ON position if a siren is attached.

### **INSTALLING A WIRELESS INTERIOR SIREN**

- 1 Plug the WIS into a non-switched outlet.
- 2 Be sure to secure the WIS to the outlet with the center outlet screw so that it cannot be accidentally unplugged.
- 3 Press the STATUS button on a Touchpad. The CPU's House Code will automatically be read and entered into the WIS. Communication from the CPU to the WIS is verified by the LED on the front of the WIS. The LED flashes every time it receives a valid transmission.

**NOTE:** If you ever wish to change House Codes, simply unplug the WIS and disconnect the battery. After a minimum of 30 seconds, reconnect the battery and plug the WIS back into the outlet. Pressing the STATUS button will reprogram the WIS with the House Code of the CPU.

**WARNING - NEVER OPEN THE WIS WHILE IT IS PLUGGED INTO A LIVE CIRCUIT, A SERIOUS INJURY OR DEATH COULD RESULT FROM ELECTRIC SHOCK.**

## CONNECTING ANOTHER SIREN TO THE W.I.S.

The WIS has two screw terminals on the back of the unit which can be connected to another self contained siren (6 VDC 100 mA maximum). By taking advantage of these terminals which are already connected to the CPU, you can avoid doing a "home run" wiring from the siren to the CPU. Connect the siren to the WIS as shown. Polarity must be observed.

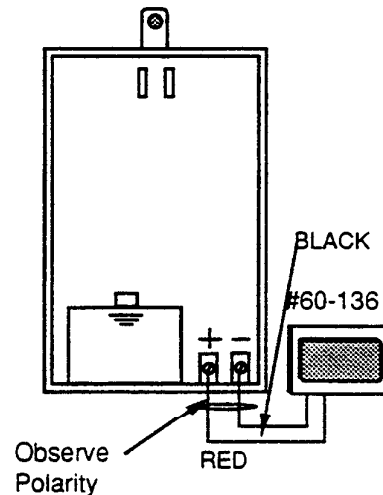

**NOTE:** Only the POLICE and FIRE alarm sounds will be activated from these terminals.

### WIS INTERFERENCE AND PHASING PROBLEMS

In a small percentage of installations a Wireless Interior Siren may experience problems.

**SIGNAL BLOCKING** - Occasionally appliances (especially TVs) can act as a filter and will block signals being sent to a WIS. If you experience signal blocking, either use a different circuit than the TV or be sure the WIS is on the near side of the circuit in relation to the CPU and the TV is beyond the WIS.

**PHASING PROBLEMS** - AC power coming into an installation site is usually broken into two different 110 volt lines, with each line serving different areas. These different lines are referred to as different line phases. Sometimes when a CPU is plugged into one phase and a WIS into another, signals will not get through properly. To overcome phasing problems, move the WIS to an outlet that is in phase with the CPU (or move the CPU to an outlet in phase with the WIS). If this is not possible, you may want to switch to a Hardwired Interior Siren or a Phone Jack Siren.

**INTERFERENCE** - The WIS uses line carrier technology for signaling. Under severe circumstances, RF interference, AC power spikes, and other "noise" on an AC power line may cause any line carrier device to operate erratically or intermittently. If you experience these problems, try installing the WIS on a different electrical circuit. If that does not help, you should install a Hardwire Interior Siren or Phone Jack Siren in place of the WIS.

# PROGRAMMING



## PROGRAMMING THE CPU

### CPU POWER-UP PROCEDURE

- 1 Turn the power switch ON. Panel will show "r rr" in the protection level and sensor number display windows. During the next 2 1/2 - 4 minutes the CPU completely checks it's RAM memory. If it finds a problem, the display will show "b ad".  
*NOTE: Panel will not power-up on battery alone. AC power must be applied.*
- 2 When the self-test is complete the CPU will respond as follows:
  - Audible trouble beeps will sound once every 60 seconds if interior sirens are installed.
  - Protection level display window will show "0".
  - CPU sensor number display will show "cS" (checksum).
- 3 If the CPU does not respond as described above:
  - Verify that the transformer is supplying 9-13.6 VDC to the CPU panel.
  - Verify that the power fuse is good (check with ohmmeter)
  - Verify that the outlet the transformer is plugged into is providing 110 VAC.
  - Verify that the transformer is providing approximately 7 - 10 VAC on screw terminal 4.
- 4 Clear the RAM only if the CPU comes on without giving the "cS" indication in the sensor number display following these steps:

The RAM Memory may have to be manually reset by the technician;

- If data from factory testing remained in the memory causing the CPU to not enter the RAM clear function upon initial power up,  
or
- For troubleshooting to set all CPU parameters to known values.

Clearing the memory on the CPU causes the CPU to perform a 2 1/2 - 4 minute RAM test. The RAM is thoroughly tested and if irregularities are discovered the CPU will indicate that there is a problem. Any programmable features, sensor numbers, phone numbers account number etc. will be erased when the RAM is cleared. *The CPU must be completely reprogrammed to become functional again.*

- 1 The CPU must be turned ON and the power transformer must be supplying voltage.
- 2 Locate the RAM CLEAR PINS and jumper on the CPU board. See wiring diagram in installation sections for location of jumper. The jumper will be installed connecting the Top and Center pins.
- 3 Remove the jumper from the Top and Center pins and install it on the Bottom and Center pins. This will force the CPU into its RAM check routine. (The display will show "r rr".)
- 4 **IMPORTANT:** As soon as the CPU display shows "r rr" remove the jumper from the Bottom and Center pins and reinstall it on the Top and Center pins.

## PROGRAMMING TOUCHPADS

### PROCEDURE

- 1 Slide the Program Review Switch to up (on).
- 2 Press 4 3 2 1 on a touchpad (puts CPU in Program Mode)  
{Display shows P PP}
- 3 Press the "STATUS" button. A bouncing ball will appear on the protection level display. If nothing occurs for 10 seconds, the display shows P PP and you must repeat step 3.
- 4 Press 11, then the "COMMAND" button.
- 5 Either press the "COMMAND" button again or enter touchpad number, then the "COMMAND" button.
- 6 Press the "BYPASS" buttons on all touchpads to be programmed for this system. All "BYPASS" buttons must be pressed in a 4 minute window or the display returns to P PP.
- 7 Press the "COMMAND" button when done.

## DELETING A TOUCHPAD

### PROCEDURE

- 1 Slide the Program Review Switch to up (on).
- 2 Press 4 3 2 1 on a touchpad (puts CPU in Program Mode)  
{Display shows P PP}
- 3 Press the "STATUS" button. A bouncing ball will appear on the protection level display. If nothing occurs for 10 seconds, the display shows P PP and you must repeat step 3.
- 4 Press 12, then the "COMMAND" button. A "H" should appear on the protection level display.
- 5 Enter the touchpad number "xx" to be deleted.
- 6 After 8 seconds, bouncing ball will confirm the touchpad has been deleted.
- 7 Repeat steps 3-6 for each touchpad to be deleted.

# PROGRAM REVIEW MODE DISPLAY SEQUENCE

Slide the Program Review Switch to up (on).

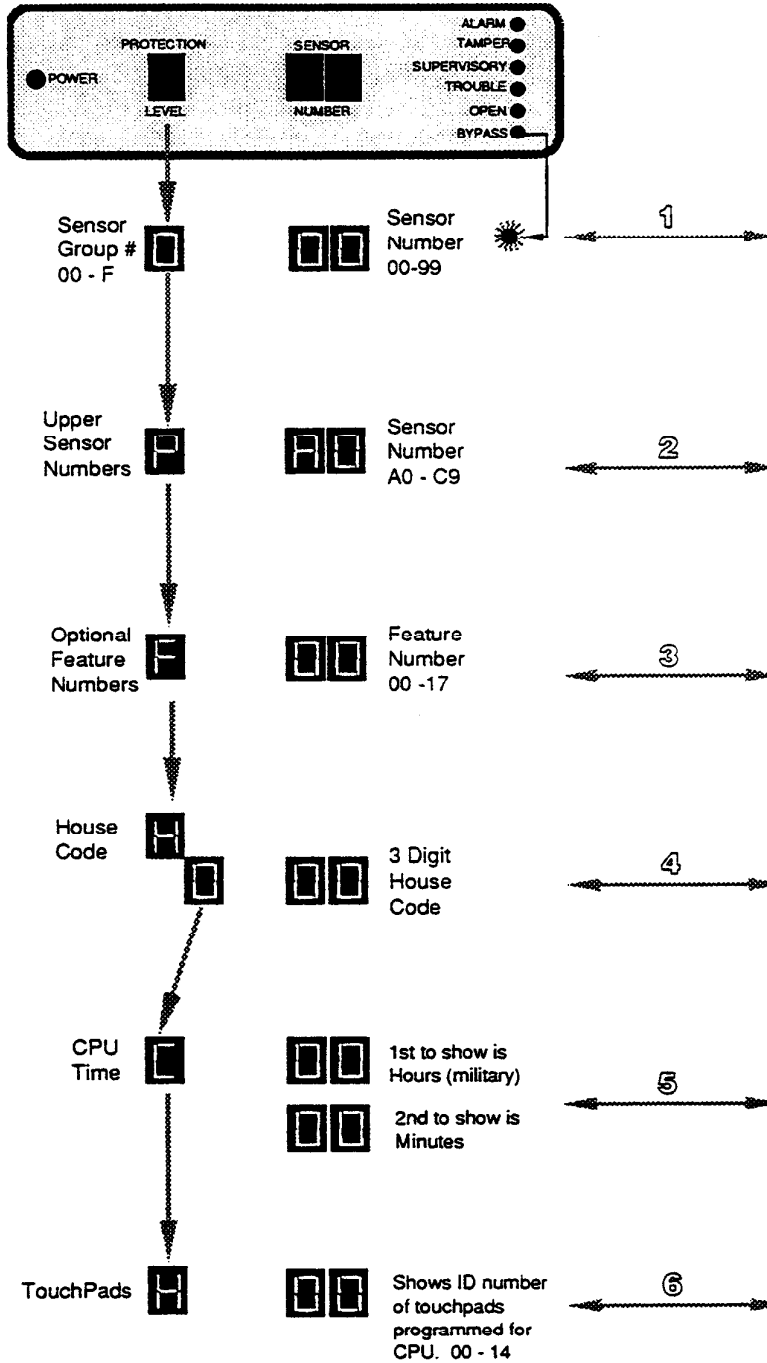

**Sequence One** shows how the sensor is grouped in the CPU memory. The protection level window shows the group number of the sensor currently displayed in the sensor number windows. The BYPASS LED when lit, indicates the current sensor displayed is programmed for a normally open switch.

**Sequence Two** indicates the Upper Sensor Numbers that are initialized in the CPU memory. The protection level window will show a "P" continuously while the sensor number windows will scroll the Upper sensor numbers A0, A1, A2 - C9.

**Sequence Three** indicates the Optional Features that are initialized in the CPU memory. The protection level window will show an "F" continuously while the sensor number windows will scroll the feature numbers (00 - 17) if active.

**Sequence Four** indicates the CPU house code. The protection level display will show an "H" prior to changing to the first digit of the house code. The sensor number windows will show the last two digits of the house code. The display will then move on to the next sequence.

**Sequence Five** indicates the time of day programmed into the CPU's memory. The protection level window will show a "C" continuously while the sensor number windows will show the hour first (in military time 00 - 23 hundred hours), and then show the minutes (00 - 59).

**Sequence Six** indicates the ID number of the Touchpads programmed for this CPU. The "H" in the protection level display will be lit continuously while the sensor number windows scroll from 00 - 14.

## SENSOR PROGRAMMING

This section describes how to program sensors. As discussed earlier, sensors are RF transmitters. They communicate with the CPU which has a built-in radio receiver. In order to successfully communicate:

1. The Sensor frequency must match the frequency of the CPU Receiver.
2. The Sensor Number assigned to each transmitter (a unique number for every sensor) must be programmed into the CPU memory.

### DETERMINE GROUP NUMBERS FOR SENSORS

If you have not yet determined which group numbers to use for the installation refer to the Group Number Chart and description below before proceeding.

### SENSOR GROUP CHART

GROUP NUMBER	SENSOR TYPE	ACTIVE LEVELS	SIREN SOUND
00	Police / Emergency	0 - 8	Loud Intermittent
01	Auxiliary / Medical	0 - 8	Low Level Siren
02	Special	1 - 7	Loud Intermittent
03	Main Entry	3 - 7	Loud Intermittent
04	Perimeter	Reports in	2
		Chimes in	2
05	Interior Delayed	Reports in	3 - 7
		Chimes in	2
06	Interior Delayed	4 - 7	Loud Intermittent
07	Interior (starts delay)	5 - 7	Loud Intermittent
08	Interior (starts delay)	4 - 7	Loud Intermittent
09	Silent Panic	5 - 7	Loud Intermittent
F (10)	Fire	0 - 8	Silent
		0 - 8	Loud Steady Tone

**NOTE:** Burglary sensors are silent in level 7.

### PROGRAMMING PROCEDURE

- 1) Enter the Program Mode and press the "STATUS" button on the Wireless Touchpad. This will momentarily clear the Sensor Number display and a bouncing ball will appear in the protection level window.
- 2) Before the display returns to all P's, press the TWO DIGITS (i.e.: 05 not 5) on the Wireless Touchpad which make up the group number of the sensor you wish to add and then press the "COMMAND" button. The group number will move to the protection level display, and the next available sensor number will appear flashing in the sensor number displays. (Data must be entered within 8 seconds or display resets to P PP.)
- 3) Press the "COMMAND" button (if you wish to use that number) OR enter the sensor number you wish to use, then the "COMMAND". The sensor number will quit flashing.
- 4) Activate the tamper button on all transmitters in that group (for smoke sensors, press the test button). NOTE: If you want the external input programmed for a normally open switch, make sure the two contacts are shorted together before activating the tamper switch.
- 5) When done with the group, press the "COMMAND" button. (4 minutes after the last sensor is activated, the display returns to P PP.)
- 6) Repeat for all other groups.

After adding all desired sensors, check the Sensor Number Window (when in program review mode) to verify all are there. The bypass LED will be lit if the sensor has been programmed for a normally open switch.

### **DELETING A SENSOR**

- 1** Enter program mode.
- 2** Press BYPASS and the two digit sensor number to be deleted. After 8 seconds, the "bouncing balls" will confirm your actions.  
If you delete several sensors, you must push the BYPASS button each time.
- 3** After deleting any sensors, check the Sensor Number Window (when in program review mode) to be sure they are gone.  
**NOTE:** Entering the wrong number of digits or a number out of the proper range prevents the change from taking effect.

## **PROGRAMMING CPU OPTIONS**

These instructions describe how to program the following information into the memory of the CPU. For many installations only a few of these items will need to be programmed. All of these parameters can be programmed or changed from a Central Station, except for sensor numbers.

SENSOR NUMBER of every transmitter

ENTRY DELAY TIME

EXIT DELAY TIME

ACCESS CODE

DURESS CODE

Any OPTIONAL SENSOR NUMBERS 100, 102, 107, 108, 110, 111, 114.

Any OPTIONAL FEATURE NUMBERS F00 through F07, F10 through F17 (F00 On at Power-up).

CPU REAL TIME CLOCK

### **TO BEGIN PROGRAMMING YOU MUST:**

- Be sure the CPU is in Protection Level 0.
- Be sure to use a Wireless Touchpad programmed in the CPU.
- Turn the Program Switch "ON" (up) to select program review mode.
- Press 4 3 2 1

The protection level and sensor number window should show "P PP".

### **FAST FORWARD PROGRAM VIEWING**

If you wish to look at a specific entry in the program while in the program review mode, press the fast forward button on the CPU board to quickly advance the program list.

### **CHANGING ACCESS CODE** (preset to 1234)

- 1 Be sure the program mode is entered and "P PP" is displayed.
- 2 Press the two MEDICAL buttons and then the desired four digit access code.
- 3 Wait for the "bouncing balls" to appear in the Sensor Number Window and for an audible beep from the interior sirens. This indicates the data was accepted.
- 4 If the bouncing balls don't appear, try again.

### **ENTERING DURESS CODE** (preset OFF)

- 1 Be sure the program mode is entered and "P PP" is displayed.
- 2 Press both POLICE buttons and the desired last two digits of the duress code, and wait for the "bouncing balls". The first two digits are the same as the Access Code set above.

**WARNING: Make the last two digits of the Duress Code totally different from ALL DIGITS of the Access Codes.**

**CHANGING ENTRY DELAY TIME** (preset at 32 seconds)

- 1 Be sure the program mode is entered and "P PP" is displayed.
- 2 Press both POLICE buttons then STATUS (1E will display on sensor number display) and then the two digit entry time in seconds, from 0 to 60, and wait for the "bouncing balls". The number entered is rounded down to a multiple of four seconds.

For U.L. Listed Systems: Entry delay shall not exceed 45 seconds.

- 3 The "bouncing balls" and audible indication confirm CPU acceptance of your programming. If they do not appear, repeat sequence.

**CHANGING EXIT DELAY TIME** (preset at 32 seconds)

- 1 Be sure the program mode is entered and "P PP" is displayed.
- 2 Press both POLICE buttons then BYPASS (0E will display on sensor number display) and then the two digit exit time in seconds, from 0 to 60, and wait for the "bouncing balls". The number entered is rounded down to a multiple of four seconds.
- 3 The "bouncing balls" and audible indication confirm CPU acceptance of your programming. If they do not appear repeat sequence.

**SETTING TEMPORARY ACCESS CODE**

Your customer can set a Temporary Access Code (for use by baby-sitter, etc.)

- 1 The program switch in the CPU must be in the OFF (down) position.
- 2 Enter the primary access code.
- 3 Press STATUS and immediately enter the desired four-digit Temporary Access Code.
- 4 Wait for the "bouncing balls" to appear in the Sensor number window of the Central Processing Unit and listen for the protection level sound that accompanies the bouncing balls.

**NOTE:** When not used, program the Temporary Access Code to be the same as the primary access code. The Secondary Access Code cannot be used to direct bypass sensors.

**CAUTION!!** Do not make the Secondary Access Code similar to the Duress Code!

**PROGRAM HOUSE CODE**

- 1 Be sure the program mode is entered and "P PP" is displayed.
- 2 Press both FIRE buttons and then enter the 3 digit house code (002 not 2).
- 3 The "bouncing balls" and audible indication confirm CPU acceptance of your programming. If they do not appear repeat sequence.

*NOTE: The house code is used for the WIS and the X-10 light modules. The house code that is entered (001-254) is mapped to the X-10 house code using the following chart.*

CPU HOUSE CODE													X-10 HOUSE CODE				
016	032	048	064	080	096	112	128	144	160	176	192	208	224	240		A	
001	017	033	049	065	081	097	113	129	145	161	177	193	209	225	241	B	
002	018	034	050	066	082	098	114	130	146	162	178	194	210	226	242	C	
003	019	035	051	067	083	099	115	131	147	163	179	195	211	227	243	D	
004	020	036	052	068	084	100	116	132	148	164	180	196	212	228	244	E	
005	021	037	053	069	085	101	117	133	149	165	181	197	213	229	245	F	
006	022	038	054	070	086	102	118	134	150	166	182	198	214	230	246	G	
007	023	039	055	071	087	103	119	135	151	167	183	199	215	231	247	H	
008	024	040	056	072	088	104	120	136	152	168	184	191	216	232	248	I	
009	025	041	057	073	089	105	121	137	153	169	185	192	217	233	249	J	
010	026	042	058	074	090	106	122	138	154	170	186	193	218	234	250	K	
011	027	043	059	075	091	107	123	139	155	171	187	194	219	235	251	L	
012	028	044	060	076	092	108	124	140	156	172	188	195	220	236	252	M	
013	029	045	061	077	093	109	125	141	157	173	189	196	221	237	253	N	
014	030	046	062	078	094	110	126	142	158	174	190	197	222	238	254	O	
015	031	047	063	079	095	111	127	143	159	175	191	198	223	239		P	



## UPPER SENSOR NUMBERS

The following is a description of pre-programmed sensor numbers resident in the CPU's memory. Those numbers that are marked with a PRE are pre-programmed. Those numbers that are marked with OPT are optional sensors that can be turned on at the time of installation if desired. You can delete or re-initialize a pre-programmed sensor according to your customer's specific installation requirements.

CPU DISPLAY	SENSOR NUMBER	ACTIVE LEVELS	DESCRIPTION
A0	100	0-8 (OPT)	PHONE TAMPER (Buddy System). If the CPU cannot report a VIOLATION for sensor numbers 01-99, 103, 104, 105, 109 or 113 to the Central Station because it detects a FAIL to COMMUNICATE (pre-programmed sensor 117) or because of NO PHONE LINE (sensor 118) it has a hardwire output that can activate a transmitter. This transmission can be heard by another CPU which is within receiving range. The CPU which hears the transmission will silently call the Central Station and report "100 ALARM! PHONE TAMPER" and identify itself with the account number of the CPU which experienced the alarm condition. Each CPU can be programmed to monitor up to 4 other CPUs within range. This programming can only be done by the Central Station. Non-Alarm reports such as Trouble or Supervisory conditions will not activate this sensor number.
A1	101	0-8 (OPT)	TOUCHPAD TAMPER. If 102 is initialized and the CPU hears 40 Touchpad signals that do not equal the proper access code, plus a protection level, then the sirens will go into audible alarm. (Police Siren) (silent in Level 5), and report "102 TOUCHPAD TAMPER" to the Central Station.
A2	102	0-8 (OPT)	HARDWIRE DEVICE -- If a hardwire buss device quits reporting in a 102 supervisory will be reported along with the unit number of the buss device.
A3	103	0-8 (PRE)	<b>24 -HOUR FIRE CALL</b> from a Touchpad. Audible.
A4	104	0-8 (PRE)	<b>24 -HOUR POLICE CALL</b> from a Touchpad. Audible.
A5	105	0-8 (PRE)	<b>24 -HOUR AUXILIARY CALL</b> from a Touchpad. Audible.
A6	106	8 (PRE)	<b>PHONE TEST</b> initiated by customer. After a successful test, all sirens sound briefly at the customers home <u>or</u> the Central Station operator should call. In addition, the 106 will clear from the CPU display and the CPU will return to Level 0.

Optional Sensor Numbers Cont.

CPU DISPLAY	SENSOR NUMBER	ACTIVE LEVELS	DESCRIPTION
A7	107	0-8 (OPT)	<p>OPENING REPORT. If 107 is initialized, the CPU will report "107 OPENING REPORT" if an arming level is changed and the level being left was a closed level (3,4,5, 6 or 7). A7 will clear from the CPU display after successfully reporting to the Central Station. You MUST initialize 108 for this feature to work properly. **</p>
A8	108	0-8 (OPT)	<p>CLOSING REPORT. If 108 is initialized, the CPU will report "108 CLOSING REPORT" if an arming level is changed and the level being entered is a closed level (3,4,5, or 6). A8 will clear from the CPU display after successfully reporting to the Central Station. You MUST also initialize 107 this feature to work properly. **</p> <p>** The CPU can be programmed from the Central Station to understand up to 34 different access codes from 34 different users. When OPENING REPORTS and CLOSING REPORTS are sent to the Central Station, the ID Number of the User whose access code armed or disarmed the system will also be reported.</p>
A9	109	0-8 (PRE)	<p><b>DURESS CODE.</b> A specially programmed access code that will send a 24-hour POLICE EMERGENCY CALL silently to the Central Station. The Duress Code must be followed by any protection level number to activate. This sensor number will not display on the CPU, it will just report. Even though sensor number 109 is pre-programmed, it will not report unless the installer has entered a duress code into the CPU memory.</p>
C0	110	0-8 (OPT)	<p><b>FORCE ARMED.</b> If 110 is initialized, the CPU will report "110 FORCE ARMED" whenever the BYPASS button is used to bypass a sensor or gain access to a protection level. The sensor number that was bypassed will also report. C0 will clear from the CPU display after successfully reporting to the Central Station.</p> <p>The CPU will automatically force arm whether or not 110 is initialized if the user fails to respond to the "PROTEST" beeps by restoring the open sensor and rearming or by deliberately bypassing the open sensor. If the user leaves the CPU protesting, it will automatically force arm after a 3 minute timeout. The CPU will arm to the protection level the user attempted to select and bypass any sensors which were not restored. A 110 Forced Armed Auto, will always be sent even if sensor 110 is not Initialized. The ID number of the user whose access code was used will also be reported.</p>

*Optional Sensor Numbers Con.*

<b>CPU DISPLAY</b>	<b>SENSOR NUMBER</b>	<b>ACTIVE LEVELS</b>	<b>DESCRIPTION</b>
C1	111	0-8 (OPT)	<b>A/C FAILURE.</b> If 111 is initialized, the CPU will report "111 A/C FAILURE" when the AC power to the CPU has been off for 15 minutes. The "Trouble" beeps will annunciate locally. Use this feature only when there is a special need. Remember, if there was a city wide power failure, all systems set to report a 111 A/C FAILURE will report at once.
C2	112	0-9 (PRE)	<b>LOW CPU BATTERY</b> After this report is sent to the Central Station (typically 2 to 3 days after AC failure), the CPU is about to shut down until the AC POWER is restored. This shut down prevents deep battery discharge and loss of CPU memory. The memory will be OK for several weeks without AC; however, the battery may need to be replaced. When the AC power is restored, the CPU will re-arm itself to the same protection level that it was in when it powered down. The CPU will report 112 A/C POWER RESTORED when the power comes back on. Up to two back up batteries can be installed in the CPU. Using two batteries will approximately double the standby time. The CPU could report 112 as a POWER SUPPLY FAILURE. This condition is usually due to a blown DC Input Fuse, a back-up battery that won't take a charge, or if the power supply chip has failed.
C3	113	1-7 (OPT)	<b>CPU TAMPER</b> The CPU is shipped with provisions for its door to be connected to a N/C hardwire tamper input. This hardwire tamper input can also have other devices such as the exterior siren tamper or RJ-31X phone cord tamper connected to it. The tamper input can be configured either N/O or N/C. The central station report will be 113 alarm tamper loop.
C4	114	0-8 (OPT)	<b>AUTOMATIC PHONE TEST.</b> If 114 is initialized the CPU will report "114 AUTO PHONE TEST" to the Central Station once every 7 days. The Central Station has the ability to change this time period to report from daily up to once every 255 days. No audible indication is given at the subscribers to indicate this test was sent.
C5	115	0-9 (PRE)	<b>RECEIVER FAILURE</b> The CPU will report "115 RECEIVED FAILURE" if it <u>does not hear from any</u> transmitter for 2 hours.
C6	116	0-8 (OPT)	<b>CPU BACK IN SERVICE</b> After the CPU has gone into its battery saver shut down routine, which is designed to prevent deep battery discharge and CPU memory loss, the 116 signal is sent when the AC power has been restored. The CPU is BACK IN SERVICE. The CPU will come back on armed to the same protection level it was in when it shut down.

*Optional Sensor Numbers Cont.*

CPU DISPLAY	SENSOR NUMBER	ACTIVE LEVELS	DESCRIPTION
C7	117	0-8 (PRE)	<b>FAIL TO COMMUNICATE</b> The CPU makes 3 attempts to contact the Central Station. If the CPU can't get through (after 3 attempts), a 117 will be displayed at the CPU and a trouble tone will sound every 60 seconds. The tone can be silenced by entering the ACCESS CODE + 0. This alarm gives a local indication only. The control unit will continue to make a total of 8 attempts to reach the central station in any of the PMODES programmed.
C8	118	0-8 (PRE)	<b>NO PHONE LINE.</b> If 118 is initialized, the CPU will check the phone line before attempting any communication with the Central Station. If the phone line is not operational, a 118 alarm is initialized, and will be displayed at the CPU. A Trouble tone will sound. The tone can be silenced by entering the ACCESS CODE + 0. This is a local indication only.
C9	119	0-9 (PRE)	<b>PROGRAM CHANGE / TOUCHPAD</b> (low BAT or SUPER). This signal is sent if a change is made to the panel while in program mode such as initializing a sensor, deleting a sensor, change the access code etc. A Supervisory or Low Battery on C9 (119) is a supervisory or low battery on a wireless touchpad. The touchpads number is sent to the CS-4000.

**NOTE:** For the purposes of this document, when sensor numbers are referred to, they will be in the Central Station Format (3 digits). Remember, the display will show the 2 digit representation of the sensor number.

EXAMPLE:      Central station receives      113  
                  Customers Touchpad shows      C3

**ADDING AN UPPER SENSOR NUMBER**

- 1 First, be sure the program switch is ON.
- 2 Press 4 3 2 1 on touchpad. Display should show "P PP".
- 3 Press the STATUS button, then 13, then "COMMAND", then the lowest digit of the sensor number you wish to add first. For example: when programming sensor number 100, you would enter 00; for sensor number 102, you would enter 02, etc.
- 4 The "bouncing balls" will confirm the CPU's acceptance.
- 5 Repeat steps 1 to 4 for each optional sensor number.

**NOTE:** The optional sensor numbers toggle on and off by using the above method. Repeat the above to remove an optional sensor number from the CPU.

## OPTIONAL FEATURE NUMBERS

The following OPTIONAL FEATURES can also be programmed into the CPU memory. They can also be added from the model CS-4000 Central Station as the other sensors can. All optional features power up "OFF" (except F00, and must be programmed into the CPU to be "ON").

FEATURE	DESCRIPTION
<b>F00 - EXIT DELAY SOUNDS</b>	<p>WHEN NOT SET - Exit delay beeps will sound only once at the beginning of the exit delay.</p> <p>WHEN SET - Exit delay beeps will sound continuously throughout the exit delay time.</p> <p>RECOMMENDATION - Set under normal circumstances (default sets this feature "on").</p>
<b>F01 - TAMPER POLARITY</b>	<p>WHEN NOT SET - The Tamper input to the CPU is Normally Closed and opens on alarm.</p> <p>WHEN SET - The Tamper input to the CPU is Normally Open.</p> <p>RECOMMENDATION - Do not set under normal circumstances as most tamper inputs will be N/C. Set if you are connecting a N/O Hardwire input to these terminals.</p>
<b>F02 - EXTERIOR SIREN DELAY</b>	<p>WHEN NOT SET - Exterior Sirens will activate at the same time as Interior Sirens.</p> <p>WHEN SET - Exterior Sirens will be delayed for 15 seconds before sounding.</p> <p>RECOMMENDATIONS - For highest security, leave it off.</p>
<b>F03 - DIGITAL COMMUNICATOR</b>	<p>WHEN NOT SET - System WILL dial the Central Station.</p> <p>WHEN SET - System will NOT report to the Central Station. The CPU should NOT be wired to the phone lines if F03 is set.</p> <p>RECOMMENDATION - Set ONLY if system is to be local non-reporting system. In U.L. applications, the dialer must be installed.</p>
<b>F04 - LOW BATTERY REPORTS</b>	<p>WHEN NOT SET - Low batteries will report daily at STIME.</p> <p>WHEN SET - Low batteries will report to the weekly at STIME.</p> <p>RECOMMENDATION - We recommend that this feature NOT BE SET so low batteries will report daily.</p>

<b>FEATURE</b>	<b>DESCRIPTION</b>
<b>F05 - SUPERVISORY REPORTS</b>	<p>WHEN NOT SET - Supervisories will report DAILY until repaired.</p> <p>WHEN SET - Supervisories will report WEEKLY until repaired.</p> <p>RECOMMENDATION - We recommend that this feature NOT BE SET so supervisories will re-report daily.</p>
<b>F06 - DIALER ABORT</b>	<p>WHEN NOT SET - System will report VIOLATION and CANCEL even if a customer cancels an alarm within the first 15-20 seconds.</p> <p>WHEN SET - System will automatically abort the call to the central station if the customer disarms within 15-20 seconds of accidentally tripping the system. (Except for Smoke, Panic Alarms and status reports.)</p> <p>RECOMMENDATION - Leave off under normal circumstances.</p>
<b>F07 - ALARM LED OPTION</b>	<p>WHEN NOT SET - Terminal 14 outputs hardwire buss information.</p> <p>WHEN SET - Terminal 14 controls an Alarm output LED.</p> <p>RECOMMENDATION - Do not set unless using an Alarm LED.</p>
<b>F10 - SIGNAL STRENGTH INDICATOR</b>	<p>WHEN NOT SET - The standard Level 9 Sensor Test is performed.</p> <p>WHEN SET - The CPU will cause Interior Sirens to beep up to 8 times as each data round is received. This feature must be turned on every time you want to hear the data rounds as it turns off as the arming level is changed.</p> <p>RECOMMENDATION - See the section of this manual called TESTING YOUR WORK, SENSOR TEST for details.</p>

FEATURE	DESCRIPTION
F11 - INTERIOR SIREN SOUND	<p>WHEN NOT SET - The Hardwire Interior sirens will sound Status and Alarm sounds.</p> <p>WHEN SET - The Hardwire Interior Sirens will Sound Alarm Sounds only - not Status sounds.</p> <p>RECOMMENDATION - The location of the Hardwire Interior Siren will determine whether or not to set this feature. A siren located in a sleeping area, for example, typically would sound alarm sounds but not status to minimize disturbances.</p>
F12 - RESTORAL REPORTING	<p>WHEN NOT SET - Violation signals will not be followed up with a Restored report when the sensor is returned to a non-alarm condition.</p> <p>WHEN SET - Violation signals set to the Central Station will be followed by a Restored report when the sensor is returned to the non-alarm state. The report will indicate the time, sensor number, and RESTORED condition.</p> <p>RECOMMENDATION - Leave not set for most installations unless the additional information of restoral time is desirable.</p>
F13 - KEY SWITCH ENABLE	<p>WHEN NOT SET - Terminal 9 is a Buddy Option output.</p> <p>WHEN SET - Terminal 9 is a key switch input.</p> <p>RECOMMENDATION - Do not set unless a key switch is used.</p>
F14 - HOURLY PHONE TEST	<p>WHEN NOT SET - The CPU will not test the telephone line it is connected to once every hour to see if there is DC current in the line.</p> <p>WHEN SET - The CPU will test the telephone line once every hour to see if there is DC current in the line. If the CPU detects a problem with the line, it will sound the "trouble " beeps (a single beep every 60 seconds from the Interior Sirens) and display a C8 Alarm on the CPU panel. The trouble beeps can be silenced by changing the arming level. If the phone line is not restored in six hours, the trouble beeps will begin again.</p>

**NOTICE** -When the CPU checks the phone line, it seizes the line for 1/2 second to sample it. If the user is on the phone at the time, a brief "click" will be heard but the line will not be cut off. However, if the line the CPU is connected to is ringing and the CPU checks the line while it is ringing the CPU will answer the call then hang up on it.

RECOMMENDATION - Typically do not set unless this is a high security application requiring frequent phone line checks. In most installations adding optional sensor number C4 AUTOMATIC PHONE TEST to test once a day provides adequate security.

<b>FEATURE</b>	<b>DESCRIPTION</b>
<b>F15 - SENSOR TAMPER</b>	<p>WHEN NOT SET - The CPU will go into alarm and report to the Central Station when it hears a "TAMPER" signal from a sensor - provided the CPU is armed to a protection level in which that sensor number is active. If the CPU is armed to a level that the sensor number is not active, the CPU will remember the "Tamper" signal and "PROTEST" as if sensor is open when the system is armed to a level in which the sensor is active. The report to the Central Station identifies the alarm as a "TAMPER".</p> <p>WHEN SET - The CPU will go into alarm and report to the central station as soon as it hears a "TAMPER" signal from a sensor regardless of the protection level the CPU is set to. The only exception is if the CPU is armed to protection level 9 - sensor test or if the sensor is bypassed. The report to the Central Station identifies the alarm as a "TAMPER".</p> <p>RECOMMENDATION - NEVER set except in very high security applications to prevent nuisance alarms.</p>
<b>F16 - TROUBLE BEEPS</b>	<p>WHEN NOT SET - The system will sound 6 quick trouble beeps once each minute to indicate a trouble condition. These beeps will sound for a supervisory 10 hours after detection, a low sensor battery 7 days after detection, a low CPU battery, if the CPU is unable to communicate, or if the CPU is left in the program mode.</p> <p>WHEN SET - The system will protest only if a sensor is open. It will not protest if there is a trouble condition with the exception of fire sensors. Smoke and heat sensors will operate as if the feature were not set.</p> <p>RECOMMENDATION - Leave "not set".</p>
<b>F17 - DIRECT BYPASS TOGGLE</b>	<p>WHEN NOT SET - Sensors which have been "Bypassed" can only be "unbypassed" by changing the CPU arming level.</p> <p>WHEN SET - Sensors which are presently "bypassed" can be un-bypassed by entering the access code + bypass + the sensor number. See the section on the Wireless Touchpad and Bypassing for more details.</p> <p>RECOMMENDATION - Leave "not set".</p>



**ADDING OR DELETING AN OPTIONAL FEATURE NUMBER**

(All optional feature numbers power up OFF except F00 and F02).

- 1 Put the CPU in the program mode
- 2 Press both MEDICAL buttons on the Touchpad for one second, then immediately press the STATUS button.
- 3 The letter "F" will appear in the sensor number display.
- 4 Press the desired feature number (from 00 - 17). Wait for the "bouncing balls" to confirm your entry.
- 5 Put into review mode and watch the CPU display to confirm that the feature number has been added to memory.

**NOTE: THESE OPTIONAL FEATURES TOGGLE ON AND OFF BY USING THE SAME PROGRAMMING METHOD. REPEAT STEPS 1 THROUGH 5.**

## **CONNECTING THE CPU TO THE CENTRAL STATION**

### **PRELIMINARY STEPS**

- Use an RJ-31X analyzer to confirm that the jack is properly wired.
- Verify that the CPU is plugged into the RJ-31X jack.
- Do not use a headset to attempt to listen to the programming while it is in progress. If you do, the CPU will not program properly.
- Remember **DO NOT** hang up the telephone until **AFTER** you put the CPU on line by entering the Access Code and Level 8 (PHONE TEST).
- Under most circumstances, programming the account number and telephone numbers takes only a couple of minutes to complete and verify. If you do not receive an acknowledgment call from the Central Station operator within 10 minutes, then either the Central Station missed the call or the call was terminated abnormally. This might tie up your customers phone line indefinitely, so you need to check to be sure the phone line is not still seized. If the line is seized then:
  1. Unplug the RJ-31X phone cord to free the line.
  2. Shut off the CPU power switch.
  3. Call the Central Station for further instructions.

## CENTRAL STATION CONNECTION

- 1 Call the Central Monitoring Station, identify yourself, and tell the operator you wish to connect a new system.
- 2 Provide the operator with the telephone number that the CPU's RJ-31X jack is connected to.
- 3 Tell the operator about any unusual requirements to access the telephone network. For example, sometimes you must:
  - Dial "1" or "120" then the number.
  - Dial "8" or "9" to get an outside line.
  - Any pauses needed.
- 4 Inform the operator of any special programming requirements.
- 5 Hang up so the operator can call back on the same line as the CPU and RJ-31X jack.
- 6 Make sure that the CPU is in the normal operating mode, *NOT* program mode.
- 7 The operator will call you back and have you run a PHONE TEST by arming the system to protection Level 8.
- 8 When you arm to Level 8, the phone will go dead. You should hang up. The Operator will program the CPU for you. The phone line will be reconnected to the house phones when the programming is completed.

The following will be programmed:

  - The customer's central station account number.
  - The central station number(s) the CPU will dial.
  - Any special programming requirements you arranged for with the operator.
- 9 Write the account number on your copy of the Customer Emergency Data Form.
- 10 To be sure that the account number and phone number(s) have been correctly programmed, initialize a PHONE TEST (Level 8). You should get acknowledgment of a successful test within 2 - 3 minutes.

## **CENTRAL STATION RECEIVER PROGRAMMING**

Although you can program most of the CPU's functions using a Wireless Touchpad, the following features and functions are typically programmed or changed from the Central Station.

### **1. CUSTOMER ACCOUNT NUMBER.**

**2. CENTRAL STATION RECEIVER PHONE NUMBER(s)** - one or two numbers can be dialed by the CPU.

**3. PMODE:** There are five phone number PMODES or options to choose from. These can be **programmed or changed only from the Central Station Receiver**, using the PMODE Command.

**PMODE 0:** In PMODE 0 Only 1 phone number is dialed, the second phone number is not used. The CPU powers up in PMODE 0 and no programming need be done if only 1 phone number is to be dialed.

**PMODE 1:** In PMODE 1 the second phone number is called only if the CPU fails to get through to the first number. The CPU will make 3 attempts to reach the first number before dialing the second number.

**PMODE 2:** In PMODE 2 the CPU dials the first number to report all alarms and cancels. The CPU dials the second number to report TROUBLE and SUPERVISORY signals only.

This PMODE would be selected by a company that wants alarm calls to go to their Central Station operators and trouble & supervisory calls to go to a different receiver in the service department.

**PMODE 3:** In PMODE 3 the CPU dials the first number to report all alarms and openings and closings. The CPU dials the second number to report everything.

This PMODE would be used by a company who has an ITI receiver and is monitored by someone else. The monitoring service would receive only alarm calls, but the alarm company would receive both a record of alarm calls and all trouble reports and supervisory reports.

**PMODE 4:** In PMODE 4 the CPU dials the first number to report all alarms. The CPU dials the second number to report everything.

This PMODE would be used by a company who has an ITI receiver and is monitored by someone else. The monitoring service would receive only alarm calls, but the alarm company would receive both a record of alarm calls and all trouble, supervisory all opening/closing reports.

4. **REPORT TIME** - The time of day that unrepaired trouble or supervisory conditions are reported to the Central Station can be changed from the Central Station. This time is preset to 12 hours upon first powering up the CPU. For example, if you first connected the battery to the CPU at 12 noon, the CPU would report any trouble and supervisories at 12 midnight. The Central Station operator will use the STIME command to change the time.
  
5. **SIREN TIMEOUT** - This is preset to 5 minutes but can be set to anywhere from 1 to 15 minutes by the Central Station Operator using the TIMEOUT Command. U.L. installations require a minimum 4 minute TIMEOUT for burglary, 5 minutes for medical.
  
6. **PROTECTION LEVEL CONTROL** - The Central Station operator can control each protection level to determine whether it is:
  - Active or disabled entirely.
  - Accessible using Hi level Access Codes only.
  - Accessible using Hi or Low level Access Codes.

For example, in a commercial installation you may want to disable or restrict all arming levels except 0,5, 8 & 9. That way the system can only be completely disarmed (Level 0), armed for maximum protection (Level 5) or tested (levels 8 & 9). The Central Station LEVEL Command is used.
  
7. **MULTIPLE ACCESS CODES** - The Central Station operator can program up to 10 Access Codes, in addition to the primary Access Code, into the CPU. Each of these Access Codes can be defined as Hi or Low privileged using the MACCESS command. If a code is Low privileged, only certain protection levels will be accessible. (See Protection Level Control).

CODE	DESCRIPTION	PROGRAM FROM	PRIVILEGE STATUS
0	Primary Access Code	CS, or WT	Always Hi
2	Alternate Primary Access Code	CS only, using MACCESS command	Always Hi
1	Temporary Access Code	CS , using MACCESS command or Touchpad	Always Low
3-10	Multi User Access Codes	CS only, using MACCESS command	Can be defined Hi or Low
11-33	Multi User Access Codes	CS only using XACCESS command	Always Low
34	Duress	CS only using XACCESS command	Always Low
35	Command	CS only using XACCESS command	Always Low

8. **PHONE TAMPER** - (Buddy System Programming) the Central Station operator can program the CPU with the Account Numbers, of up to 4 other CPU's within its receiver range. If one of the other CPU's can't communicate with the Central Station because of a **PHONE TAMPER**, it can trip a transmitter programmed to Sensor Number 100. The "BUDDY" CPU will hear the transmission and relate the House Code to one stored in its memory. It will then report a **PHONE TAMPER** using the account number of the CPU which couldn't communicate.
9. **CPU TIME and DATE** - The Central Station Operator can program the time of day and day of the year into the CPU. This is to keep track of events as they occur in the CPU event buffer.
10. **EVENT BUFFER** - The CPU keeps a record of all arming and disarming, alarm, trouble, cancel, and supervisory signals in an event buffer. The last 64 events are stored. The Central Station Operator can review this data using the **EVENT COMMAND** and can also clear the buffer from the CS.
11. **AUTOMATIC PHONE TEST** - From the Central Station, the operator can program how often the CPU will perform an Automatic Phone Test (optional sensor number 113). This is programmable from once daily to once every 255 days using the **PTFREQ Command**.
12. In addition, the Central Station operator can change the **DURESS CODE**, turn options **ON** or **OFF**, change **ENTRY** and **EXIT DELAYS**, etc.

## **BUDDY SYSTEM BACK-UP REPORTING CAPABILITIES**

The CPU has a hardwire output which can activate a transmitter in the event of a phone tamper condition. This output is activated only if the CPU is trying unsuccessfully to report an alarm condition. It does not activate for trouble, supervisory or other reports. Another CPU installed within receiving range of the transmitter can be programmed to "listen" for signals from the transmitter. The "listening" CPU will look at the Identification Number of the signal it hears. If it matches an Identification Number stored in the CPU memory, it will silently report the ALARM PHONE TAMPER condition and the account number of the CPU which tried to report the original alarm signal.

### **PRELIMINARY CONSIDERATIONS**

- The transmitter must be within range of the "listening" CPU.
- Each CPU can monitor up to 4 other CPU's for Phone Tamper.
- CPU's can back-up each other, for example: CPU A could store the ID Number and Account Number of CPU B and vice versa.
- Both CPUs must have sensor 100 in memory.
- Only the Model CS-4000 Central Station can set up CPUs for this feature.
- The door/window transmitter shall be mounted within 30 feet of the CPU.

### **PROGRAMMING**

- 1 Place CPU in the program mode.
- 2 Press "STATUS", then 14, then "COMMAND". The CPU will display the next available buddy number..

NOTE: Install Jumper on Transmitter before tripping.

- 3 Trip the tamper on the transmitter that is connected to the CPU to be monitored. Bouncing Balls will confirm programming.
- 4 Connect dependent CPU to the programmed transmitter.
- 5 Repeat steps 1 - 3 for each buddy CPU to be monitored.
- 6 Call the monitoring center with data to program host CPU with dependent account.
- 7 Program ACCOUNT numbers into each CPU from the Central station (CS-4000).
- 8 Test your work.

### **TRANSMITTER CONNECTIONS**

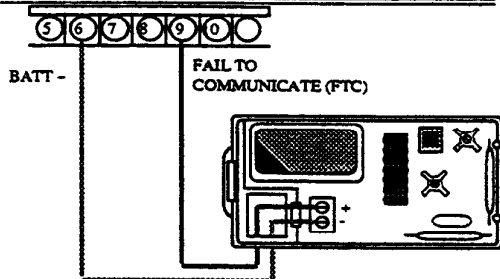

Connect the programmed sensor to the CPU as shown in the drawing at left. Remove the unused reed switches if maximum security is desired.

Transmitter	CPU
+Terminal	Screw 9 (FTC)
-Terminal	Screw 6 (-BATT)

**WARNING:** The buddy CPU (host) supervised the dependent CPU's transmitter (#00) and vice versa. A buddy supervisory in this context is actually a defective or otherwise inoperative transmitter which is connected to the dependent CPU.

## TESTING

### TESTING YOUR WORK CHECKLIST

After all devices are installed and programming is complete the system should be thoroughly tested.

- Test for proper arming to all protection levels
- Test secondary Access Code
- Test Duress Code
- Test Standby Power
- Test AC Power/Transformer
- Test Bypass Feature
  - Direct
  - Indirect
  - Automatic
- Test Open Sensor Protest
- Test Alarm Memory
- Test Phone connections to CS
- Test any other features you have added.
- Test all Sensors using Sensor Test.
- Test all Sensors using Level 9 Sensor Test.



## TESTING YOUR WORK

After all the components of the system are in place, and the CPU has been programmed, the entire system should be checked out using the procedures outlined in this section.

### PROTECTION LEVEL TEST / STATUS TEST

- 1 Disconnect the RJ-31X jack, if connected.
- 2 Place each Wireless Touchpad on its mounting bracket. **THIS IS IMPORTANT!**
- 3 Arm to each protection level, 1 to 7. Listen for proper STATUS beeps.
- 4 Push the STATUS button at each level.
- 5 Activate various sensors about the house. Be sure the sensors that are supposed to work at each protection level do, and the ones that are supposed to be disarmed at each level are.
- 6 Disarm to Level 0 between each arming, or go directly from one arming level to another.
- 7 Repeat above from every Wireless Touchpad location.
- 8 Select protection Level 0 to end test.
- 9 Reconnect the RJ-31X plug when test is complete.

### TESTING TEMPORARY ACCESS CODE

Following the procedure in the programming section, enter a secondary access code from one of the Touchpads. Try the Temporary Access Code by arming the CPU to a new protection level to be sure it works properly.

Now, delete the Temporary access code by making it the same as the primary access code. To do this enter the primary Access Code, push STATUS, then enter the primary access code again.

### SENSOR TEST

Sensor Test (Protection Level 9) is used to verify a secure and reliable communications link between the CPU and each of the sensors at the installation site. It also allows testing of the communications between each Wireless Touchpad and the CPU. Additionally, the CPU standby battery is checked since the CPU automatically switches to battery power when Level 9 is selected.

#### NOTES ABOUT SENSOR TEST

- When the system is set to protection Level 9, it cannot call the Central Station and affords no protection except DURESS calls. Thus, the CPU will automatically go to protection Level 0 fifteen minutes after entering Level 9. This restores basic (fire, panic, etc.) protection.
- Reentering Level 9 (without going to any other level) will reset the 15 minute timer, without changing the display, to give you more test time.
- If Optional Feature F10 is programmed into the CPU, the interior sirens will beep up to 8 times as each data round is received. This feature must be turned on every time you want to hear the data rounds as it turns off as the arming level is changed.

## SENSOR TESTING

<u>ACTION</u>	<u>CORRECT RESPONSE</u>
1. Select protection Level 9. (optionally set F10)	All the sensors you programmed, plus pre-programmed sensors 103, 104, & 105 should scroll through the sensor number display. Be sure everything is OK.
2. Activate each door/window sensor	You should hear a loud "beep" (or series of 2-3 times beeps for each data round) from all interior sirens as each sensor tests and its sensor number will be removed from the scroll. The sensor number being tested will momentarily display when activated, then it will disappear.
3. Test each Passive Infrared (PIR) at various distances within its pattern.	Listen for the loud "beep" (or series of beeps) as you test each sensor. Remember the PIR needs 3 motion free minutes before each test.
4. Test each Smoke Sensor 2-3 times.	Press and hold the test button on the Smoke Sensor for 20 to 30 seconds until the internal horn sounds and the sensor number is removed from the display.
5. Test each Portable Panic Button from several places.	Point out to your customer any poor reception areas (if any) within the installation.
6. Activate all other sensors in same manner.	Listen for the loud "beep" (or series of the beeps) as you test each sensor.
7. Activate all the emergency (POLICE), buttons from EVERY Touchpad.	Sensor Number 103 (FIRE), 104 (Police) and 105 (MEDICAL) should be removed from the display.
8. Check to see if any numbers still appear on the display.	If so, retest these sensors.

## DURESS CODE TEST

**NOTE:** The policy at most Central Stations is to NEVER cancel a Duress Code. Thus, the police will be dispatched whenever a duress code is reported, even if a canceled report is sent with it. Therefore, be sure to call the Central Station before beginning a Duress Code test.

The DURESS Code will have the same first two digits as the customer's Access Code, the last two digits will be different. The DURESS Code can be entered at any time, in any protection level.

### ACTION

1. Call Central Station and inform them of the Duress Code test by identifying yourself and giving the correct customer account number. Ask the Central Station Operator to call you back when the test comes through. Give the operator the correct phone number.
2. Select any protection level by entering the Duress Code rather than the Access Code.
3. Enter the customer's ACCESS CODE + 0 from a Touchpad.
4. Wait for Central Station Operator to call and confirm the receipt of an "109" alarm.

### CORRECT RESPONSE

- Central Station Personnel authorize the Duress Code test, and repeat correct account number being tested and the phone number of the installation site.
- The interior sirens will sound the appropriate number of beeps for the protection level selected.
- CPU should disarm.
- They should call within two minutes to confirm successful Duress Code test.

## STANDBY POWER TEST

Follow the actions below and verify the correct indications and response to check the standby power.

<u>ACTION</u>	<u>CORRECT INDICATIONS / RESPONSE</u>
1. Unplug the CPU's transformer.	<ul style="list-style-type: none"><li>• The CPU display should remain lit.</li><li>• After a few seconds the power LED will blink. (It glows steady when the CPU has AC power).</li></ul> <p>If the display goes blank immediately then either the CPU battery is dead or disconnected; or the BATTERY FUSE has blown and must be replaced. <u>All memory may be lost.</u></p>
2. Verify that the system operates using only standby power by selecting 2 or 3 different protection levels.	<ul style="list-style-type: none"><li>• System responds just as it would if operating on AC power.</li></ul>
3. Plug the transformer into the AC outlet and resecure the screw.	<ul style="list-style-type: none"><li>• After a few seconds the power LED will glow steady again.</li></ul>

**NOTE:** The CPU has a power conservation procedure which will shut off the CPU visual displays, except for the power LED, after approximately 15 minutes of drawing from the standby battery. Pressing the Status button will light the display momentarily. An alarm will light the display for approximately 5 minutes.

## AC POWER / TRANSFORMER TEST

<u>ACTION</u>	<u>RESPONSE</u>
1. Carefully disconnect the <u>positive</u> battery lead from terminal #5.	<ul style="list-style-type: none"><li>• Everything should remain the same</li></ul>
2. Verify that the system is working properly.	<ul style="list-style-type: none"><li>• System responds just as it would if battery were connected.</li></ul>
3. Reconnect the battery lead.	

## INDIRECT BYPASSING TEST

<u>ACTION</u>	<u>CORRECT INDICATIONS / RESPONSE</u>
1. Select protection Level 0.	<ul style="list-style-type: none"><li>• CPU protection level display shows "0".</li></ul>
2. Deliberately open any exterior sensor (group numbers 3 & 4) and note its number.	<ul style="list-style-type: none"><li>• The sensor is open and remains open.</li></ul>
3. Select protection Level 3.	<ul style="list-style-type: none"><li>• CPU will not change protection levels (protection level display = "0").</li><li>• Interior sirens will produce the "protest" beeping sound.</li><li>• The number of the open sensor will be displayed. (NOTE: If more than 1 sensor is violated, the sensor numbers of all violated sensors will be displayed).</li><li>• All six sensor condition LED's will blink simultaneously. (ALARM, TAMPER SUPERVISORY, TROUBLE, OPEN and BYPASS ).</li></ul>
4. Select protection Level 0.	<ul style="list-style-type: none"><li>• "Protest" beeping ceases.</li></ul>
5. Select protection Level 3, then press the BYPASS key.  (ACCESS CODE + 3 + BYPASS)	<ul style="list-style-type: none"><li>• Interior sirens will indicate the protection level.</li><li>• The CPU protection level LED reads "3".</li><li>• The numbers of any sensors which were BYPASSED are displayed and the BYPASS LED lights.</li></ul>
6. Close and open the bypassed sensor or sensors a couple of times.	<ul style="list-style-type: none"><li>• The bypassed sensor or sensors do not cause an alarm when closed then opened.</li></ul>

**NOTE:** With indirect bypassing you can only bypass sensors such as those on doors or windows which can be left in the alarm condition while attempting to arm the system.

### DIRECT BYPASSING TEST

<u>ACTION</u>	<u>CORRECT INDICATIONS / RESPONSE</u>
1. Select protection Level 0.	<ul style="list-style-type: none"><li>• CPU protection level display shows "0".</li></ul>
2. Select protection Level 3.	<ul style="list-style-type: none"><li>• CPU will arm to Level 3. The CPU display shows "3" and the sirens sound a group of 3 beeps.</li></ul>
3. Reenter the Access Code + BYPASS + the sensor number you want to bypass. (Choose a number which would be active in protection Level 3.)	<ul style="list-style-type: none"><li>• The CPU display will remain at Level 3. The number of the sensor you bypassed will display and the BYPASS LED will light.</li></ul>
4. Activate the bypassed sensor a couple of times.	<ul style="list-style-type: none"><li>• The bypassed sensor does not cause an alarm when tripped.</li></ul>

**NOTE:** Using direct bypassing you can bypass any sensor number, including smoke detectors and passive infrareds.

### OPEN SENSOR PROTEST TEST

<u>ACTION</u>	<u>CORRECT INDICATIONS / RESPONSE</u>
1. Select protection Level 0.	<ul style="list-style-type: none"><li>• CPU protection level display shows "0".</li></ul>
2. Deliberately open one or more exterior sensors.	<ul style="list-style-type: none"><li>• The sensor is open and remains open. CPU shows sensor number and lights the OPEN LED.</li></ul>
3. Select protection Level 3.	<ul style="list-style-type: none"><li>• CPU does not change protection levels. (Protection level display = 0.</li><li>• Interior sirens produce the "protest" beeping sound.</li><li>• The number of the open sensor(s) will be displayed on the CPU.</li><li>• All six condition LEDs blink simultaneously.</li></ul>
4. While the CPU is protesting close the open sensors.	<ul style="list-style-type: none"><li>• When all open sensors are closed the protest beeping will stop.</li><li>• The sensor(s) numbers will clear from the display.</li></ul>
5. Select protection Level 3.	<ul style="list-style-type: none"><li>• The CPU protection level changes to 3.</li><li>• The system properly arms to Level 3.</li></ul>

## ALARM MEMORY TEST

ACTION	CORRECT INDICATIONS/ RESPONSE
1. Select protection Level 3. (ACCESS CODE + 3)	• The CPU protection level display shows "3".
2. Activate a sensor which is armed in Level 3. Remember this sensor numbers.	• Activating the sensor causes the CPU to go into its appropriate alarm sound.  • The number of the tripped sensor appears on the CPU display and the Alarm LED lights.
3. Select protection Level 0 to silence the sirens.	• The CPU protection level display shows "0".  • The sirens stop.  • Be sure to disarm quickly so the Central Station operator will not dispatch the authorities.
4. While watching the CPU display press the "STATUS" button on a Touchpad.	• Interior sirens will sound one long beep indicating protection Level 0.  • The sensor which was activated will momentarily be displayed when the Alarm LED is lit.

**NOTE:** The alarm memory will clear automatically six hours after the protection level is changed. To clear it immediately, arm the system to Level 9.

## PHONE TEST

The PHONE TEST verifies a secure and reliable telephone communications link between the customer's CPU and the Central Station Receiver.

<u>ACTION</u>	<u>CORRECT RESPONSE</u>
1. Verify that the phone cord is plugged into the RJ-31X jack.	<ul style="list-style-type: none"><li>• If not, connect it now.</li></ul>
2. Notify the Central Station of your tests.	
3. Select protection Level 8.	<ul style="list-style-type: none"><li>• Listen for correct audible status response.</li></ul>
4. Observe CPU display.	<ul style="list-style-type: none"><li>• Should show protection Level 8. Also, the Sensor Number window should display "A6" and the Alarm LED will be lit.</li></ul>
5. Wait 2 minutes for these three indications of a successful communications test.	<ol style="list-style-type: none"><li>(1) A6 will clear from the display and the protection level will change to Level 0 when the test is successfully received by the central station receiver.</li><li>(2) If the test feature is kept on at your Central Station, it will automatically activate the customers sirens causing them to sound each of their alarm sounds for two seconds each.</li><li>(3) Central Station will phone you and confirm receipt of test.</li></ol>



## **MAINTENANCE AND INSPECTIONS**

Regularly scheduled maintenance and inspections (at least yearly) are necessary to keep alarm systems in proper working order. Offer a regular maintenance schedule to the system owner and user in addition to advising the user in the system's operation and limitations. Recommendations would include but not be limited to specific guidelines for weekly testing of the system.

The user may not under any circumstances try to service or repair the system; repairs must be done by the factory or an authorized dealer.

### **ALARM SYSTEM LIMITATIONS**

Not even the most advanced alarm system can guarantee protection against burglary or fire. All alarm systems are subject to compromise or failure-to-warn for a variety of reasons:

- If sirens or alarms are not placed within hearing range of persons sleeping or in remote parts of the house. Warning devices may not be heard if they are placed behind doors or other obstacles, or on levels distant from space frequently occupied by residents.
- If intruders gain access through unprotected points of entry, or areas where sensors have been bypassed
- If intruders have the technical means of bypassing, jamming, or disconnecting all or part of the system.
- If power to detectors is discontinued or inadequate. Devices will not work if the AC power supply is off and backup batteries are either missing, dead, or improperly installed.
- If smoke does not reach the detector. Smoke detectors cannot detect smoke in chimneys, in walls or roofs, or smoke blocked by a closed door. They may not detect smoke or fire on a level of the building different from the one on which they are located. Sensors may not be able to warn in time about fires started by smoking in bed, explosions, improper storage of flammables, overloaded electrical circuits, or other types of hazardous conditions.
- If transmission lines are out of service. Transmissions from the CPU to a Central Monitoring Station cannot be made over lines that are out of service. Telephone lines are also vulnerable to compromise by any of several means.

Inadequate maintenance is the most common cause of alarm failure. Therefore, the system should be tested at least once per week to be sure sensors, sirens, the communicator, etc. are all working properly.

Although having an alarm system may make the owner eligible for reduced insurance premiums, the system is no substitute for insurance. Warning devices cannot compensate for loss of life or property.

## **TELEPHONE PROBLEMS**

Should problems develop with the telephone system, unplug the CPU from the RJ-31X jack. If a problem still exists after disconnecting the CPU, notify the telephone company. If the regular phone works after the CPU has been disconnected from the phone lines, this indicates a problem with the CPU, RJ-31X jack or your wiring.

If this condition exists

- Thoroughly check the RJ-31X wiring.
- With the power switch OFF check terminals 15 and 16, as well as 17 and 18 for continuity with an ohmmeter. These contacts should be SHORTED since the CPU is in a non-dialing condition.

Upon installation of the system, demonstrate disconnection of the phones to your customer.

Disconnecting the phone connection inside the CPU will result in loss of power from the phone lines.

### **FEDERAL COMMUNICATIONS COMMISSION REGULATIONS**

This equipment is in compliance with Federal Communications Commission (FCC) Part 15, Subpart J and E and Part 68 where applicable. Each device carries a label giving the specifics and conditions of compliance. The FCC requires that you be informed of the following:

This equipment complies with FCC Rules Part 15. Operation is subject to the following two conditions: (1) this equipment may not cause harmful interference and (2) this equipment must accept any interference that may be received, including interference that may cause undesired operation.

For additional help consult your dealer or an experienced radio/television technician. See also the FCC booklet, "How to Identify and Resolve Radio-TV interference Problems." This booklet is available from the U.S. Government Printing Office, Washington D.C. 20402. Stock No. 004-000-00345-4.

## APPENDIX A

---

# HARDWIRE OUTPUT MODULE

Part #60-370

### OVERVIEW

The Hardwire Output Module (HOM) gives the CPU the ability to output a DC. voltage to eight separate lines. These lines go high (+5 VDC) when specific zones are violated, when minor or major trouble conditions exist, and for various other reasons. The HOM is connected with a four-wire cable directly to the CPU, to another HOM or to another device on the hardwire buss such as a Hardwire Touchpad with Display.

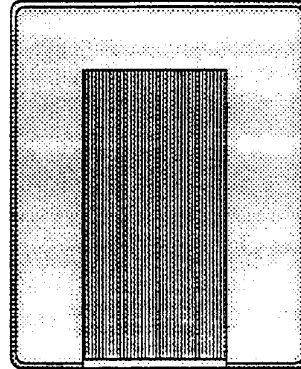

### PRELIMINARY CONSIDERATIONS

1. The HOM will work only with the ITI CPU.
2. The HOM draws 10 mA. The total power consumed from the Hardwire Buss can be no more than 500 mA. Total the current requirements for your buss devices to determine if an additional power supply is needed.
3. All programmed data is stored in a removable E<sup>2</sup>PROM. If the circuit board were to be changed, the chip could be moved to the new board to retain the programming.
4. The HOM has a removable terminal strip for easier wiring.
5. The HOM requires a four conductor wire. It is recommended that you use 20 gauge or greater stranded jacketed cable. In some long run instances shielded cable should be used.
6. The HOM sends supervisory signals for the tamper zone to the CPU just like wireless sensors. The CPU looks at these signals the same as if it were a wireless zone.
7. The HOM's plastic case can be tampered by using a reed switch connected between terminals #9 - #10. The plastic base has a molded housing for the reed switch (1/4 inch drill mount) and the top cover will hold the magnet. Opening the cover will open a normally closed switch.

## INSTALLATION AND WIRING INSTRUCTIONS

1. Determine the location of the HOM and run a four conductor cable to the location. The HOM (with plastic case removed) may also be mounted inside the CPU itself and secured to the metal mounting tabs using 3/4" screws. We recommend remote mounting, however, because wiring is difficult with the HOM inside the cabinet. With the CPU power off, connect the cable to the CPU terminals or another device connected to the Hardwire Buss.
2. Carefully remove the circuit board, then mount the HOM base using the three mounting holes provided. Be sure and handle the board by its edges to avoid static problems.
3. Carefully reinstall the HOM circuit board.
4. If needed, remove the terminal strip and connect the CPU input wiring to the HOM. The output lines of the HOM will go from 0 to 5.0 VDC at 100 mA when activated.
5. Now wire the output lines to the dialer, long range radio, or other device. If you are going to power the external device from the HOM, it must operate at 6.8 VDC. Remember 500 mA is the total current supplied from the CPU Buss supply. There is a switched supply available from the HOM on terminals #11. This will supply 5.5 VDC at 200 mA. This supply is used to power a dialer in the event of a major failure condition. It will switch off 3 minutes after the failure to give the dialer ample time to communicate the failure to the central station.
6. Verify that all wiring is correct and the terminal strip is seated properly before applying CPU power.

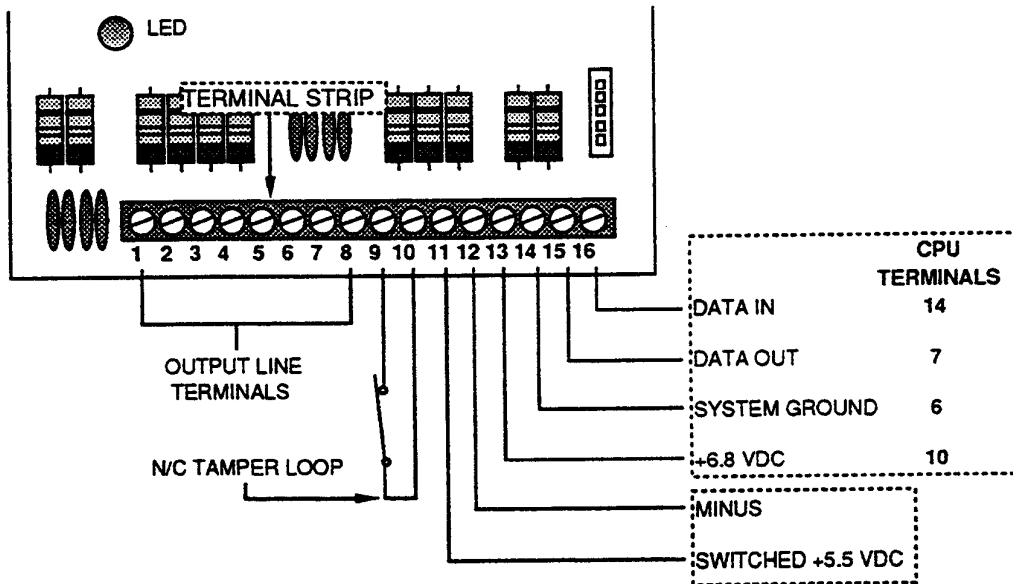

## PROGRAMMING THE HOM

### Standard Configuration

\* Turn CPU power switch back on at this time.

1. With the HOM wired to the CPU (or any other 'Buss' device) plug the programming cable from the Hand Held Programmer into the Programming Jack. **Polarity must be observed. The open face of the programmer cable must be toward the outside edge of the HOM board.** Note: If your programmer displays a decimal point following the "HELLO", the software will not work in programming the HOM.

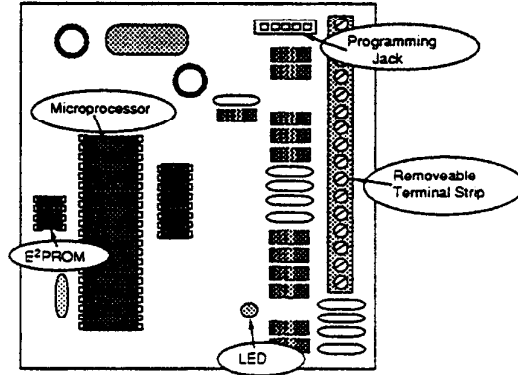

2. Press the House Code Button on the Programmer. Then enter the Unit ID Number for the Hardwire Buss. This number can be from 0 to 7 and must not be the same as any other device on the Hardwire Buss.
3. (NOTE: The LED must be on to program the tamper switch sensor number, to turn the LED on press the read key on the programmer until the LED comes on). If you want to tamper the HOM plastic case and the reed switch is in place, press the Sensor Number Button on the Programmer, enter the desired sensor number (any number but '0' will work). Now press the Sensor Type Button on the Programmer, the only options you can select for programming are Normally/Open, Normally/Closed for the tamper switch. All other options on the programmer are not used and won't effect the HOM operation. The tamper zone is supervised and the tamper zone will continue sending data until an acknowledge is received from the CPU.
4. Press the Enter key on the Programmer. The display will show DONE or FAIL. If FAIL is displayed repeat steps 1 through 3 making sure entries are valid.
5. Press READ key on the Programmer to verify your programming.
6. Finally place the CPU in the Program Mode. Program the tamper zone the same as a wireless zone. It is recommended that a Level 9 Sensor Test be performed to verify tamper programming.

### TROUBLE LED

The LED on the board acts as a tamper, programming, and trouble indicator. In normal operation it is *OFF*.

If this LED is *Flashing*, there is a communication problem with the CPU. For example: if two different Buss devices had the same unit ID number, the LED would flash, indicating a Buss communication problem (the CPU will also show "A-2 supervisory", if two devices have the same unit ID number).

If the LED is *Solid ON*, the memory has been lost.

## HARDWIRE OUTPUT MODULE OUTPUT LINE CONFIGURATIONS

The HOM has two modes of operation: **Standard** and **Programmed**. The standard mode of operation is similar to that of other panels that trip external dialers; the programmed mode of operation gives the system expanded flexibility. A jumper on the PCB determines the mode of operation. If the jumper is not in place, the standard configurations are used. (The jumper is included with the HOM.) If the jumper is in place on the jumper pins, the programmed mode will be used; the jumper also enables the EEPROM to be programmed for data storage. (If power is lost, the EEPROM will retain memory.) Seven of the eight lines can be programmed; the Major Trouble condition from the Standard configuration is not programmable, so that a system failure may always be communicated. The other 7 lines can be programmed to any one of a set of predetermined configurations. The programming will be done with the Handheld Programmer.

The following is a list of the Standard configurations that are possible on the HOM.

### STANDARD OUTPUT LINE CONFIGURATIONS

#### **Fire Alarms - Momentary**

#### **Configuration 00, Output line 1**

All sensors assigned to Group #10 at the CPU that are in an alarm condition will cause activation of the output line. The output will deactivate at a level change or 3 minutes, whichever occurs first. *Default sensor is #103.*

#### **Silent Panic and Duress Alarms - Momentary**

#### **Configuration 01, Output line 2**

All sensors assigned to Group #9 at the CPU that are in an alarm condition. The output line will deactivate at a level change or 3 minutes whichever occurs first. *Default Sensor is #109.*

#### **Intrusion Alarms - Momentary**

#### **Configuration 02, Output line 3**

All sensors assigned to groups #2 (Special), #3, #4 (Perimeter), #5, #6, #7, #8 (Interior) at the CPU that are in alarm condition. The output line will deactivate at a level change or 3 minutes whichever occurs first. *This is commonly used to report all burglary type alarms.*

#### **Audible Panic alarms - Momentary**

#### **Configuration 03, Output line 4**

All sensors assigned to Group #0 at the CPU that are in an alarm condition. The output line will deactivate at a level change or 3 minutes, whichever occurs first. *Default sensors are #102,104.*

#### **Medical and Environmental - Momentary**

#### **Configuration 04, Output line 5**

All sensors that are assigned to Group #1 at the CPU. The output line will deactivate at a level change or 3 minutes, whichever occurs first. *Default Sensors are #105.*

**Minor Trouble Conditions - Momentary**                      **Configuration 05,  
Output line 6**

Any one of the following conditions will cause immediate activation. These conditions will deactivate at a level change or 3 minutes, whichever occurs first. 1) All SUPERVISORY conditions on any sensor. 2) All TROUBLE conditions on any sensor: **Sensor #111** in ALARM - A/C power failure (group 14). **Sensor #112** in ALARM - CPU low battery (group 14). **Sensor #119** in ALARM (group 13). *These conditions, if they occur, will not affect the ability of the CPU to detect ALARMS, except if the sensor in TROUBLE or SUPERVISORY is activated.*

**Major Trouble Conditions - Momentary**                      **Configuration 06,  
Output line 7**

***Non-Programmable***

Any one of the following conditions will cause immediate activation. This condition will deactivate at a level change or 3 minutes, whichever occurs first. **Sensor #115** - Receiver failure (group 14) **Sensor #117** - CPU to CS-4000 failure (group 11). **Sensor #118** - Phone line failure (group 11). **Communication failure** over the hardwire buss to this device (on own 3 minute timer). **Loss of EEPROM memory** at this HOM (in program mode of operation). *These conditions will affect the ability of the CPU to detect ALARMS. This configuration/output line is not programmable in case of system failure. This is so a report can be done.*

**Phone Test & Weekly Test - Momentary**                      **Configuration 7,  
Output line 8**

Sensors #106 (Phone test) and #114 (Weekly test) are in ALARM (both in group 13). The output line will deactivate at a level change or 3 minutes whichever occurs first. *This configuration could be used to test a backup communicator at the same time that the CPU is testing it's dialer.*

## **PROGRAMMABLE OUTPUT LINE CONFIGURATIONS**

### PROGRAMMING THE OUTPUT LINES

1. A jumper block must be installed on the two vertical pins located slightly off center on the HOM board.
2. With the HOM wired to the CPU (or any other ITI Bus device), plug the programming cable from the Programmer into the Programming Jack. **Polarity must be observed. The open face of the programmer cable should be toward the outside.** Note: If your programmer displays a decimal point following the "HELLO", the software will not work in programming the HOM.
3. Press the House Code Button on the Programmer. Then enter the Unit ID Number for the Hardwire Buss. This number can be from 0 to 7 and must not be the same as any other device on the Hardwire Buss. If the HOM case is to be tampered, follow the instructions listed in Standard Configuration #3. \* The tamper zone cannot be programmed with the jumper block installed! (Program tamper zone first, then install jumper.)
4. Press the Sensor Number key and enter the chosen Configuration number from the chart.
5. Press the Sensor Type key and enter a Output line, terminal 1 - 6, or 8. This assigns what output line will go high (+5.5 VDC) for that particular configuration (seven is not programmable, and is always used for major trouble output).

### PROGRAMMABLE CONFIGURATION CHART

The following is a list of the Programmable configurations that are possible on the HOM:

#### **Special Intrusion Alarms - Momentary**

##### **Configuration 10**

All sensors assigned to Group #2 (special) at the CPU that are in an alarm condition. The output line will deactivate at a level change or 3 minutes, whichever occurs first. *Used to report ALARMS into gun cabinets or wall safes.*

#### **Interior Intrusion Alarms - Momentary**

##### **Configuration 11**

All sensors assigned to Groups #5, #6, #7, #8, (Interior) at the CPU that are in an alarm condition. The output line will deactivate at a level change or 3 minutes, whichever occurs first.

#### **Exterior Intrusion Alarms - Momentary**

##### **Configuration 12**

All sensors assigned to Groups #3, #4 (exterior) at the CPU that are in an alarm condition. The output line will deactivate at a level change or 3 minutes, whichever occurs first.



**Intrusion Alarms Excluding Exit Delay - Momentary**

**Configuration 13**

All sensors assigned to Groups #2 (Special), #3, #4 (Perimeter), #5, #6, #7, #8, (Interior) at the CPU that are in an alarm condition and not caused by an exit delay. The output line will deactivate at a level change or 3 minutes whichever occurs first. *Used to report only true break-in situations. The exterior delayed intrusion sensors will be ignored if the operator did not get out quickly enough or left a door open.*

**Silent Intrusion Alarms - Momentary**

**Configuration 14**

All sensors assigned to Groups #2 (Special), #3, #4 (Perimeter), #5, #6, #7, #8, (Interior) at the CPU that are in an alarm condition when the arming level is 7 (Silent). The output line will deactivate at a level change or 3 minutes whichever occurs first. *Used to report burglary ALARMS when no sirens are enabled at the site.*

**Audible Intrusion Alarms - Momentary**

**Configuration 15**

All sensors assigned to Groups #2 (Special), #3, #4 (Perimeter), #5, #6, #7, #8, (Interior) at the CPU that are in an alarm condition when the arming level is 3, 4, 5, 6. The output line will deactivate at a level change or 3 minutes, whichever occurs first. *Used in conjunction with configuration #14 to get all intrusion ALARMS.*

**Intrusion Alarms W/Activation Delay - Momentary**

**Configuration 16**

Same as Configuration 02, only the output line does not activate until a 30 second delay is over. *Used to facilitate dialers with no abort feature or to give pre-alarms.*

**Special Alarms W/Activation Delay - Momentary**

**Configuration 17**

Same as Configuration 10 only the output line does not activate until after a 30 second delay. *Used to facilitate dialers with no abort feature or to give pre-alarms.*

**Interior Alarms W/Activation Delay - Momentary**

**Configuration 20**

Same as Configuration 11 only the output line does not activate until a 30 second delay is over. *Used to facilitate dialers with no abort feature or to give pre-alarms.*

**Exterior Alarms W/Activation Delay - Momentary**

**Configuration 21**

Same as Configuration 12 only the output line does not activate until a 30 second delay is over. *Used to facilitate dialers with no abort feature or to give pre-alarms.*

**Intrusion Alarms Except Exit Delay W/Delay - Momentary**

**Configuration 22**

Same as Configuration 13 only the output line does not activate until a 30 second delay is over. *Used to facilitate dialers with no abort feature or to give pre-alarms.*

**Silent Intrusion Alarms W/Activation Delay - Momentary**

**Configuration 23**

Same as Configuration 14, only the output line does not activate until a 30 second delay is over. *Used to facilitate dialers with no abort feature or to give pre-alarms.*

**Audible Intrusion Alarms /Activation Delay - Momentary**

**Configuration 24**

Same as Configuration 15 only the output line does not activate until a 30 second delay is over. *Used to facilitate dialers with no abort feature or to give pre-alarms.*

**Intrusion Alarm Memory W/Modulation - Sustained**

**Configuration 25**

All sensors assigned to Groups #2 (Special), #3, #4 (Perimeter), #5, #6, #7, #8, (Interior) at the CPU that are in an alarm condition. The output line will toggle ON (1 second), OFF (1 second) and deactivate with a level change. *Used to notify returning person of possibly dangerous situation at the protected site.*

**Intrusion Alarm Memory - Sustained**

**Configuration 26**

All sensors assigned to Groups #2 (Special), #3, #4 (Perimeter), #5, #6, #7, #8, (Interior) at the CPU that are in an alarm condition. The output line will turn on until a level change. *Same uses as Configuration 25 without modulation.*

**Fire Alarm Memory - Sustained**

**Configuration 27**

All sensors assigned to Groups #10 (Fire) at the CPU that are in an alarm condition. The output line will deactivate with a level change. *Used to light escape routes during fire. The default sensor that fall into this configuration is #103.*

**Intrusion & Fire Alarm Drive - Momentary (16 Mins.)**

**Configuration 30**

All sensors assigned to Groups #10 (Fire) that are in an alarm condition and all sensors in Groups #2 (Special), #3, #4 (Perimeter), #5, #6, #7, #8, (Interior) that are in an alarm condition if the CPU is not in level 7. The output line will deactivate after 16 minutes or with a level change, whichever occurs first. *Can be used to drive a strobe light, sirens to scare off would-be burglars. The default sensors that fall into this configuration are #103 and 113.*

**Intrusion & Fire Alarm Drive - Momentary (5 Mins.)**

**Configuration 31**

Same as Configuration 30 except deactivation occurs after 5 minutes or level change, whichever is first. *The default sensors that fall into this configuration are #103 and 113.*

**Fire Alarms W/Activation Delay - Momentary**

**Configuration 32**

Same as Configuration 00 only the output line does not activate until a 30 second delay is over. *Used to facilitate dialers with no abort feature or to give pre-alarms.*

**CPU to Monitoring Station Failure - Momentary**

**Configuration 33**

Sensors #117 (Fail to communicate) and #118 (Phone line failure) assigned to group #11 in alarm. The output line will deactivate at a level change or 3 minutes, whichever occurs first. *Used as an early warning for backup communicator that the CPU communicator has failed.*

**CPU Low Level Siren Drive**

**Configuration 34**

This output will follow the high level siren drive. Steady for fire and modulated for intrusions. *Can be used to drive a light for the deaf or auxiliary sirens.*

**CPU High Level Siren Drive**

**Configuration 35**

This output will follow the low level siren drive. *Can be used to drive a light to indicate arming level or entry/exit delay in instances where sirens cannot be heard.*

**System Armed Status - Sustained**

**Configuration 36**

If the CPU arming level is 3, 4, 5, 6, and 7, the output line will be active. For all other levels the output line will be inactive. *Used to drive an LED indicating a disarmed state at an entry door.*

**System Disarmed Status - Sustained**

**Configuration 37**

If the CPU arming level is 0, 1, 2, 8, and 9, the output line will be active. For all other levels the output line will be inactive. *Used to drive an LED indicating a disarmed state at an entry door.*

**Opening Report - Momentary**

**Configuration 40**

If Sensor #107 is assigned to Group #13 and is in ALARM condition, the output line will deactivate at a level change or 3 minutes, whichever occurs first. *Used to report the arrival of employees at a business site.*

**Closing Report - Momentary**

**Configuration 41**

If Sensor #108 is assigned to Group #13 and is in ALARM condition, the output line will deactivate at a level change or 3 minutes, whichever occurs first. *Used to report the departure of employees at a business site.*

**Energy Saver Daytime Set Point Driver - Sustained**

**Configuration 42**

If the CPU is in level 0, 1, 2, 3, 8, or 9, the output line will be in the active state. In all other levels the output line will be deactivated. *Used to energize a relay to connect a thermostat for when user is home.*

**Energy Saver Away Driver - Sustained**

**Configuration 43**

If the CPU is in level 5, 6 or 7 (Away), the output line will be in an active state. In all other levels, the output line will be inactivated. *Used to energize a setback thermostat when nobody is home.*

**Energy Saver Nighttime Driver - Sustained**

**Configuration 44**

If the CPU is in level 4 (Night), the output line will be in an active state. In all other levels the output line will be inactivated. *Used to energize a setback thermostat when user is sleeping.*

**Energy Save At Home Driver - Sustained**

**Configuration 45**

If the CPU is in level 0, 1, 2, 3, 4, 8, or 9, the output line will be in an active state. In all other levels the output line will be inactivated. *Used up to 2 thermostat system in conjunction with Configuration 43.*

*The following configurations use sensors assigned into Group 11. This group does not report, but is audible with trouble beeps in levels 0-6 and 8-9.*

**Non-Audible Control - Momentary**

**Configuration 46**

All sensors, assigned to Group 11 that are in alarm will cause immediate activation of the output line. The output will deactivate at level change or 15 minutes whichever occurs first. *This could be used to turn on an exterior light in response to an outdoor perimeter sensor. The home owners would remain undisturbed.*

**Non-Audible Control W/Modulation - Momentary**

**Configuration 47**

All Sensors, assigned to Group #11 that are in alarm will cause immediate activation of the output line. The output will deactivate at a level change or 15 minutes whichever occurs first. *This could be used to turn on/off an exterior light in response to an outdoor perimeter sensor. The home owners would remain undisturbed.*

**Non-Audible Control-Sustained**

**Configuration 50**

All Sensors, assigned to Group 11 that are in alarm will cause immediate activation of the output line. The output will deactivate at a level change.

. . .

## APPENDIX B

### Key Switch

#### Overview

The key switch is designed to provide a simple on and off operation for the system. The CPU defaults to "ON" level 5 and "OFF" level 0. To change either or both of these levels, The monitoring center must be notified, and the operator through the Central Station Receiver can change these levels.

#### Installation and Wiring

1. Determine location of the key switch
2. Run wire from the CPU to that location.
3. Install and connect a maintained contact key switch.
4. Connections

Key switch Terminals	CPU Terminal Strip
NO. 1	2
NO. 2	9

#### Programming the switch

1. Enter CPU into program mode.
2. Then press MED-MED + Status + 13
3. This program field, F13, will enable the key switch to operate.

**CAUTION:** Only one switch can operate properly on one CPU.

**Note:** The system will not arm if a supervisory or low battery condition exists or if a device is open.

#### CPU Terminal Strip

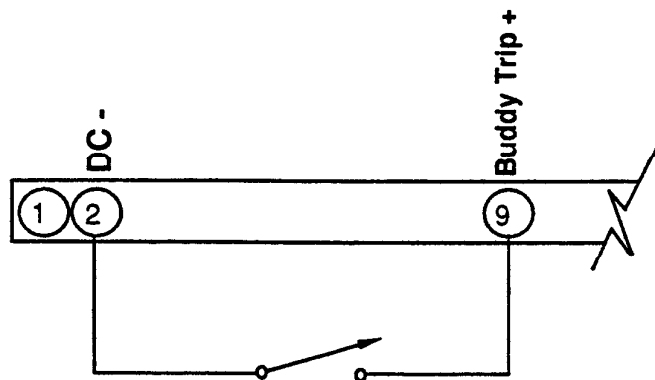

#### Keyswitch Option

1. Initialize F13 for keyswitch operation
2. Levels will operate the system (RAMC can change this).  
OFF = Level 0  
On = Level 5
3. Must use maintained contact switch

## APPENDIX C

### ALARM LED

#### Overview

The alarm LED is designed to provide a visual indication of past and current alarm conditions.

**CAUTION:** *When this feature is activated, the hardwire buss will not operate any other device. This feature should be offered only if no other device is required to operate from the hardwire buss.*

The following devices will NOT operate if alarm LED feature is activated:

- Hardwire Touchpad
- Hardwire Input Module
- Hardwire Output Module

#### Operation

The LED is designed to act as a memory display to show if an alarm occurred during the past arming period. If lit, there was a violation during the past arming period. Any change in arming level will clear the LED

#### Installation and Wiring

1. Select location for LED with single gang electric outlet cover plate.
2. Run two-conductor wire to CPU.
3. Turn off CPU.
4. Connect Wiring.

#### LED Connections

LED positive lead  
(with series 270 Ohm,  
1/2 Watt Resistor)

Red - 10

LED Negative lead

Black - 14

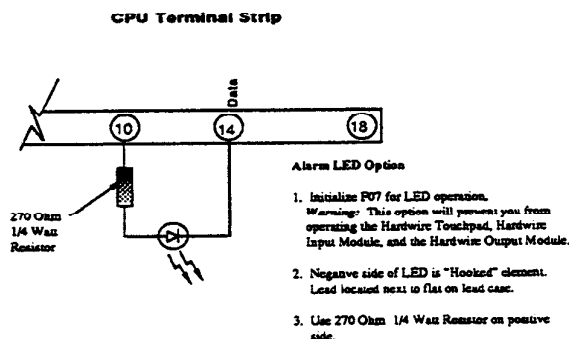

#### Programming the Alarm LED

1. Enter CPU into program mode. (program switch up, enter 4321 from touchpad).
2. Press MED-MED + Status + 07.
3. Wait for "bouncing balls" (approx. 10 seconds).
4. Test by causing a violation and see if LED lights.

**NOTE:** The LED will light up if a change has been made to the CPU program because 119 is sent to The monitoring center each time any change is made the CPU program.

## APPENDIX D

### Wireless Shatterbox 5745-03

Follow the location selection and mounting procedures enclosed with each 5745-03. Caution: The wiring diagram in the "installation" instruction is not correct for transmitter connections. Use the schematic diagram below to connect this device.

#### Overview

The 5745-03 is rated to protect areas 35 feet and 20 feet high. The tester is accurate only within this rated pattern. For larger areas, use additional Shatterbox detectors. Curtains, blinds, and other window coverings will absorb energy from breaking glass. Heavy curtains, for example, will effectively block the sound signal.

#### NOTE:

- 1) When the window has coverings, through pre-testing is required. Use the tester behind the coverings if they will be closed by the user.
- 2) The Shatterbox responds only to framed glass. Do not test the Shatterbox by breaking an unframed pane of glass.

#### Installation and Wiring

1. Connect the black and red wires from the connector cable provided in the box as shown in the diagram following this text. Do not connect white wire until sensor is programmed into CPU.
2. Enter CPU program mode.
3. Select group for Shatterbox transmitter.
4. Activate the TAMPER on the transmitter.
5. Connect white lead as shown.
6. Assemble unit by putting the transmitter into Shatterbox case. Take care to properly fold the wire.
7. Test in level 9.

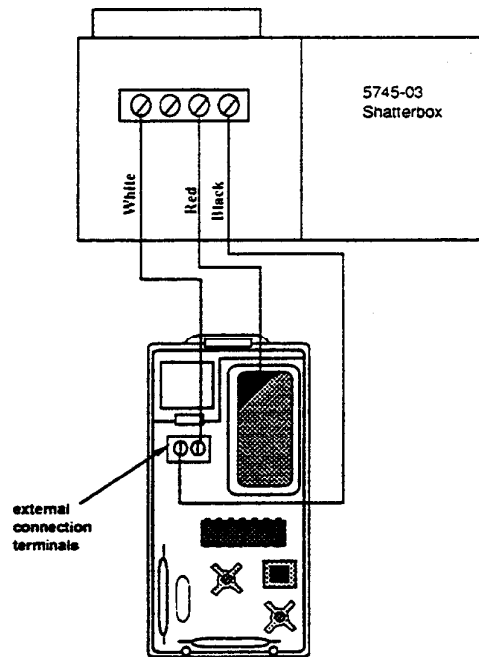

## APPENDIX E

### Shock Sensor Sentrol 5105

#### Overview

The Sentrol 5105 Glasstrap is a piezo electric shock sensor. It converts impact energy to electrical impulse. Undisturbed, it has about 5 Ohms of resistance across terminals. On impact, it will go "open": to 1 Meg Ohm. The leads are polarity sensitive. You must connect them exactly as shown in diagram below.

The 5105 Glasstrap does not require field adjustment. It comes in three colors: Off white, gray, and mahogany.

#### Installation and Wiring

1. Install on clean, dry surface with double side pad provided in the package.
2. Program the transmitter into CPU. (see sensor programming)
3. Connect the 5105 Glasstrap to the transmitter.
4. Test in level 9 with the use of shock emulator.

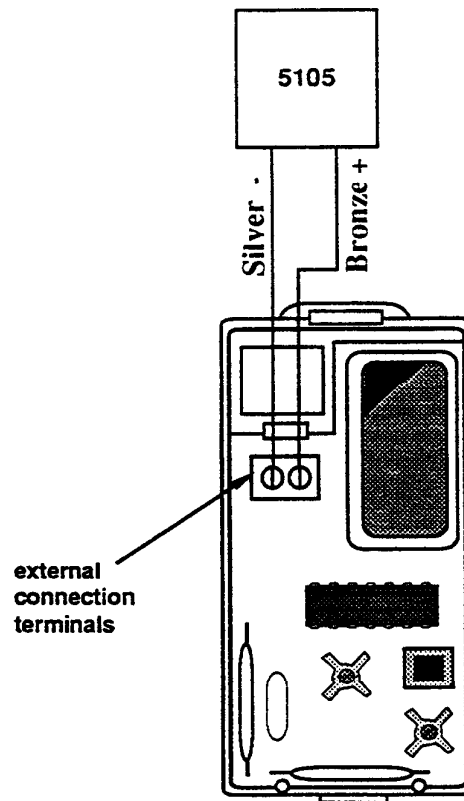



---

---

## APPENDIX F

### SD11-17 Siren Driver

#### Connections

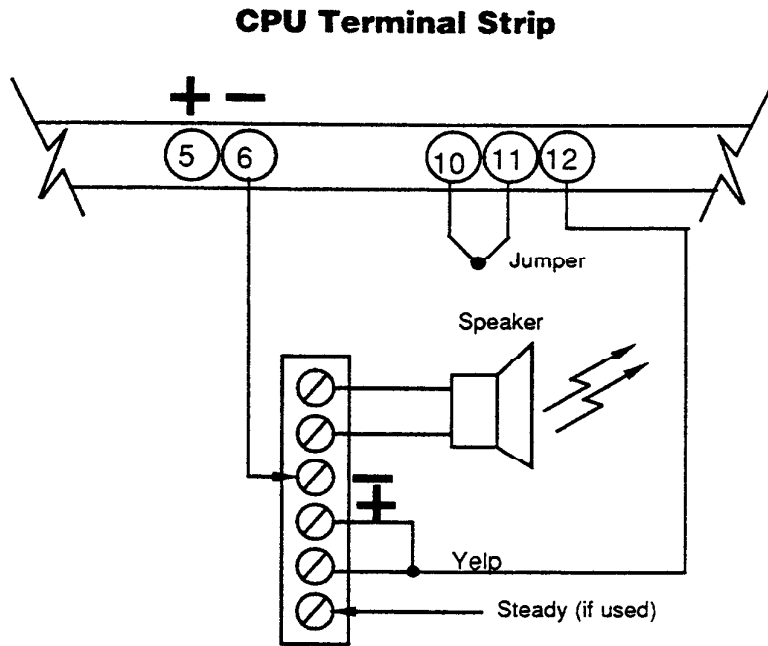

## APPENDIX G

### Hardwire Input Module (HIM)

Part # 60-242

#### Overview

The Hardwire Input Module (HIM) allows the addition of 8 normally open (NO) or normally closed (NC) zones to the CPU. Each zone has an individual E.O.L. resistor for supervision. The Handheld programmer is used to program the HIM. The HIM is connected to the CPU by a four conductor cable.

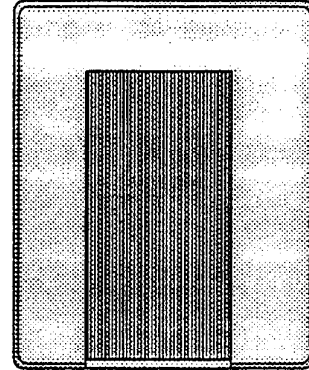

**Caution:** Only four (4) Hardwire Buss Modules can be connected to the CPU.

#### INSTALLATION AND WIRING

- 1) The HIM circuit board can be removed from its plastic case and mounted remotely from the CPU. Remove the circuit board and mount the case using #6 panhead screws with anchors.
- 2) Disconnect all power to the CPU by disconnecting the power supply and the battery. Using 20 gauge wire, connect the HIM to the CPU as shown. Using 22 gauge or greater wire, connect your hardwire loops on the HIM. Verify that the end-of-line resistors are installed properly (Normally Open in parallel, Normally Closed in series.)

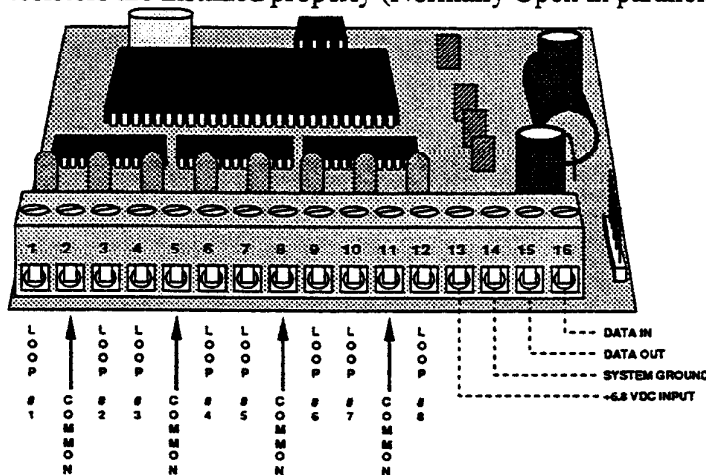

#### Connections

HIM Terminal Strip	System VI Terminal Strip	Color
13	10	RED
14	6	BLACK
15	7	WHITE
16	14	GREEN

- 3) Be sure power is off when you plug the strip back in. Double check the wiring and be sure the terminal strip is seated properly. Restore power back to the CPU.

## PROGRAMMING THE HIM

- 1) Make sure that the HIM is wired to the CPU properly.  
NOTE: EOLR must be in place for all zones - even unused zones.
- 2) Plug the programming cable from the programmer into the Programming Jack. Polarity must be observed. The open face of the programmer displays a decimal point following the "HELLO". If the software will not allow programming of the HIM contact your branch office for updates.

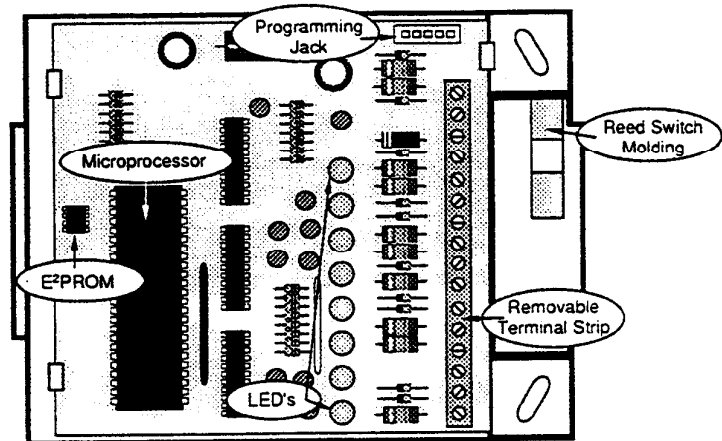

NOTE: If a period is showing after the HELLO, replace the programmer. The software needs to be updated.

- 3) Press the READ button on the programmer. One of the LED's will light. This LED corresponds to the zone or loop you are programming. By pressing the READ button, you can toggle through the 8 LED's to select the zone you wish to program.
- 4) Press the HOUSE CODE button on the programmer. Enter the Unit ID number for the Hardwire Buss. This number can from 0 to 7 and must be the same as any other device on the Hardwire Buss. Never use two consecutive ID numbers such as 1 and 2 or 0 and 1. Always use an ID sequence such as 0 and 2, 1 and 3, etc.
- 5) Press the SENSOR NUMBER button. This is followed by the two-digits of the sensor number for the zone.
- 6) Now press the SENSOR TYPE button on the programmer. Enter the Type on the programmer. NOTE: The programming option keys operate the same as an RF sensor except for the Supervised and Fire Panic Priority buttons. All zones are supervised and each zone will continue sending data until an acknowledgment is received from the CPU.

NOTE: Make sure that all closed loops are programmed for RESTORAL.

- 7) Press the ENTER key on the programmer. The display will show DONE or FAIL. (If FAIL is displayed, repeat steps 1 through 5 making sure entries are valid.)
- 8) Press READ to verify your programming.
- 9) Press READ again to step to the next zone and continue programming all devices hardwired to the HIM.
- 10) Put any unused zones to sleep using the programmer.
- 11) Place the CPU into program mode.

- 12) Enter the type of sensor you wired to the first zone on the HIM in the following manner:
  - a. STATUS + GROUP + COMMAND + 1ST SENSOR NUMBER. (The first zone or sensor in the HIM must be the same as the sensor number in the CPU for that zone.
  - b. Activate the first zone/sensor on the HIM. This will "teach" that number into the CPU memory.
  - c. Now activate each zone/sensor in the same sequences as they are programmed in the HIM. This will scroll the numbers in the CPU in the same sequence, matching the zone/sensor designations.
- 13) Turn the CPU program switch to OFF.
- 14) You must test each sensor connected to the HIM. This will verify programming. Be sure to set the CPU to level 9 test first.

### HOW TO CHANGE A SENSOR NUMBER ON A HIM

- 1) Turn CPU program switch ON.
- 2) Plug the programmer cable into the HIM. Make sure to observe proper polarity. The open face of the programmer cable should be toward the outside.
- 3) Press the READ button to step to the zone you wish to program.
- 4) Press the sensor number key and enter the new sensor number.
- 5) Press ENTER. The display should read "Done". Press READ to verify programming.
- 6) To remove the previous Sensor Number from CPU, use a wireless or hardwire touchpad. Enter BYPASS and the sensor number. The bouncing balls in the display will confirm the bypassing.
- 7) To enter the new sensor number, repeat step 12 in the programming the HIM section.
- 8) Turn the program switch OFF

### HOW TO CHANGE A UNIT ID NUMBER OF A HIM

- 1) Turn CPU program switch ON.
- 2) Plug the programmer cable into the HIM. Make sure to observe proper polarity. The open face of the programmer cable should be toward the outside.
- 3) Turn the programmer ON.
- 4) Press the READ button. This should light the first LED on the HIM.

- 5) Press the HOUSE CODE button and enter the desired ID number (0-7). Do not duplicate ID numbers!
- 6) Press ENTER. The display should read "Done". Press READ to verify your programming. If it reads "Fail", check for proper polarity on programmer plug and repeat steps 5 and 6, making sure entries are valid.
- 7) Activate a zone in the HIM. This will send the new ID to the CPU.
- 8) Turn the CPU program switch OFF.

### TROUBLE LED

The LED that corresponds to the Number One Loop also acts as a trouble indicator

- If this LED is Flashing, there is a communications problem with the CPU.
- If the LED is constantly illuminated, the HIMs memory has been lost.



Interactive Technologies, Inc.  
2266 North Second Street  
North St. Paul, MN 55109

©1993 Interactive Technologies, Inc.

46-638 Rev. A